

VOGATEC Sàrl

TRIAG

*Fourniture pour décolletage
Mécanique de précision*



**Outils de précision & Technique serrage
TRIAG AG Präzisionswerkzeuge & Spanntechnik**

CH-6319 Allenwinden | Aussergrütstrasse 2
Tél. (f) +41 (0) 41 727 27 96 | Tel. (d+e) +41 (0) 41 727 27 27
Fax +41 (0) 41 727 27 99
E-Mail: office@triag.ch | www.triag.ch



**POUSSETTES SIMPLES POUR TOURS AUTOMATIQUES TORNOS
EINFACHE STOSS-STANGEN FUER LANGDREHAUTOMATEN TORNOS
SIMPLE PUSHRODS FOR AUTOMATICS TORNOS**

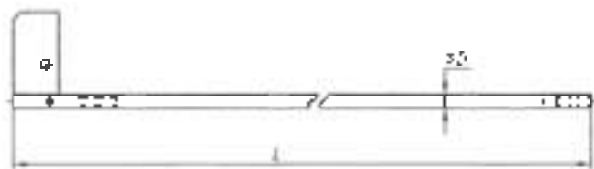

N° de code Bestell Nr Order Nr	Machines TORNOS TORNOS maschinen TORNOS machines	Ø D mm	L mm	Prix Frs Preis Price
VO1100.0000	M-4	4,50	430	46.00
VO1101.0000	M-4	4,50	510	46.00
VO1102.0000	T-4	4,50	510	46.00
VO1103.0000	M-7	6,50	565	48.00
VO1104.0000	MS-7	6,50	665	48.00
VO1105.0000	MS-7	10	882	74.00
VO1106.0000	R-10	10	755	74.00
VO1107.0000	R-125	12	533	87.00
VO1108.0000	R-125	12	711	87.00
VO1109.0000	R-16	16	750	89.00
VO1100.0000	RR-20	20	750	101.00
VO1111.0000	MR-28	25	800	112.00
VO1112.0000	MR-32	30	800	122.00

**POUSSETTES SIMPLES POUR TOURS AUTOMATIQUES TORNOS AVEC ARRÊTAGE
EINFACHE STOSS-STANGEN FUER LANGDREHAUTOMATEN TORNOS MIT STOPPVORRICHTUNG
SIMPLE PUSHRODS FOR AUTOMATICS TORNOS WITH STOPPING**

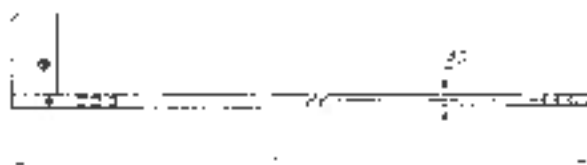

N° de code Bestell Nr Order Nr	Machines TORNOS TORNOS maschinen TORNOS machines	Ø D mm	L mm	Prix Frs Preis Price
VO1113.0000	R-10	10	825	46.00



POUSSETTES TUBES VIBO POUR TOURS AUTOMATIQUES TORNOS
VIBO STOSS-STANGEN FUER LANGDREHAUTOMATEN TORNOS
PUSHRODS VIBO FOR AUTOMATICS TORNOS

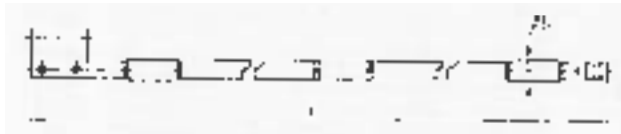

N° de code Bestell Nr Order Nr	Machines TORNOS TORNOS maschinen TORNOS machines	Ø D mm	L mm	Prix Frs Preis Price
VO1114.0000	R-10	10	540	110.00
VO1115.0000	R-16	16	605	151.00
VO1116.0000	RR-20	20	750	174.00
VO1117.0000	M-25	25	600	190.00
VO1118.0000	MS-28	28	600	310.00
VO1119.0000	MR-32	30	635	322.00

POUSSETTES TUBES VIBO POUR TOURS AUTOMATIQUES TORNOS AVEC ARRÊTAGE
VIBO STOSS-STANGEN FUER LANGDREHAUTOMATEN TORNOS MIT STOPPVORRICHTUNG
PUSHRODS VIBO FOR AUTOMATICS TORNOS WITH STOPPING

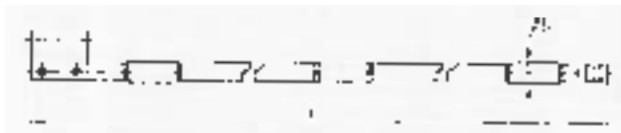

N° de code Bestell Nr Order Nr	Machines TORNOS TORNOS maschinen TORNOS machines	Ø D mm	L mm	Prix Frs Preis Price
VO1120.0000	R-10	10	710	130.00

POUSSETTES TORNOS NA-12 TUBE DE RAVITAILLEMENT À HUILE
STOSS-STANGEN TORNOS NA-12
PUSHRODS TORNOS NA-12

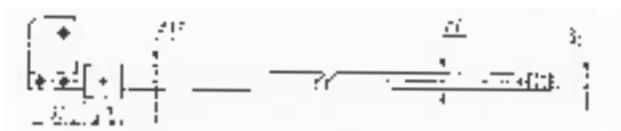

N° de code Bestell Nr Order Nr	Machines TORNOS TORNOS maschinen TORNOS machines	Ø D mm	L mm	Prix Frs Preis Price
VO1121.0000	NA-12	10	891	180.00



POUSSETTE POUR TUBE À HUILE TORNOS Ø7MM
STOSS-STANGE FUER FUEHRUNGSROHRE MIT OELBAD TORNOS Ø7MM
PUSHROD FOR FEED TUBES WITH OILBATH TORNOS Ø7MM

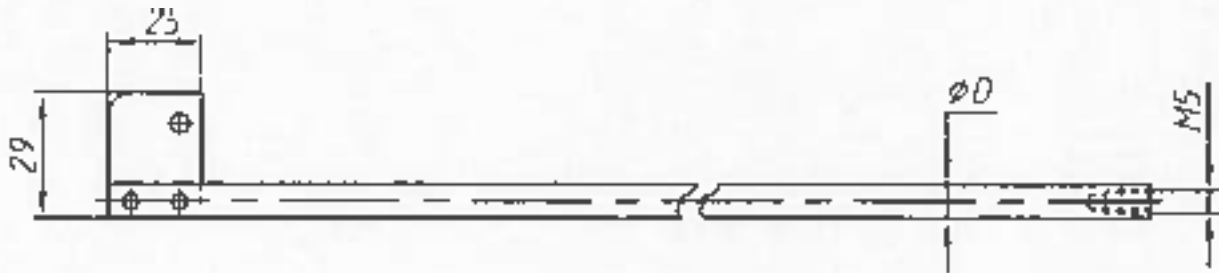

N° de code Bestell Nr Order Nr	Machines TORNOS TORNOS maschinen TORNOS machines	Ø D mm	L mm	Prix Frs Preis Price
VO1122.0000		6,50	910	150.00

POUSSETTE TORNOS ENC-16
STOSS-STANGE TORNOS ENC-16
PUSHROD TORNOS ENC-16

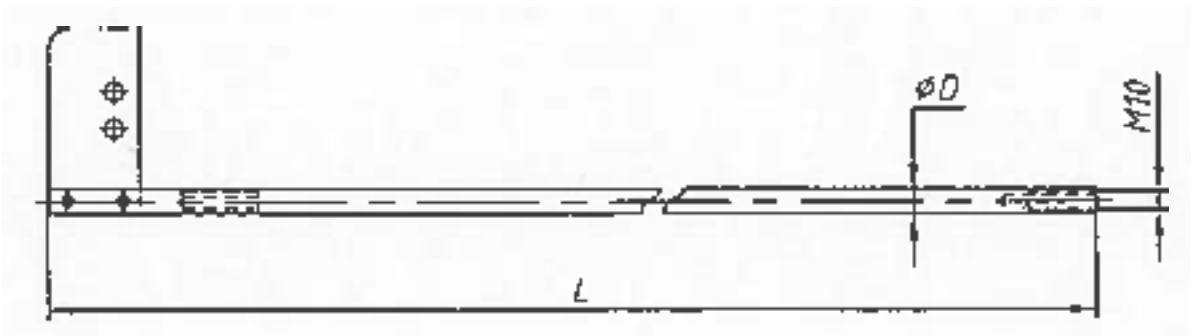

N° de code Bestell Nr Order Nr	Machines TORNOS TORNOS maschinen TORNOS machines	Ø D mm	L mm	Prix Frs Preis Price
VO1123.0000	ENC-16	16	840	165.00



DRAPEAUX INTERCHANGEABLES (vissés)
AUSWECHSELBARE STOSS-STANGENFAHNEN (geschraubt)
CHANGEABLE PUSHRODS FLAGS (screwn on)

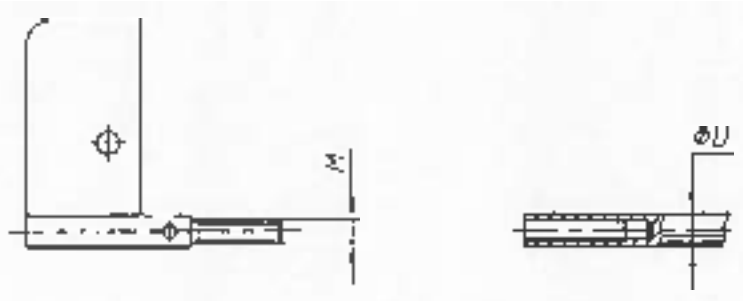

N° de code Bestell Nr Order Nr	Poussette Stoss-stange Pushrods	Ø D mm	M mm	Prix Frs Preis Price
VO1130.0000		7,50	M5 x 0,5	25.00
VO1131.0000		10	M8 x 0,5	25.00

DRAPEAUX POUR TUBES SILENCIEUX OU VIBO
FAHNEN GERAEUSCHARME ROHRE ODER VIBO ROHRE
FLAGS FOR SILENT TUBES OR VIBO TUBES

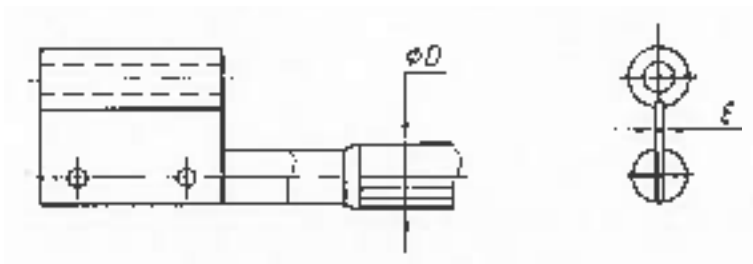

N° de code Bestell Nr Order Nr	Poussette Stoss-stange Pushrods	Ø D mm	E mm	Prix Frs Preis Price
VO1143.0000		10		28.00
VO1144.0000		16		35.00
VO1145.0000		20		40.00
VO1146.0000		25		42.00
VO1147.0000		28		44.00
VO1148.0000		30		46.00
VO1149.0000		32		50.00



**EMBOUTS TOURNANTS SIMPLES POUR POUSSE-BARRES
EINFACHE DREHENDE ENDSTUECKE FUER STOSS-STANGEN
SIMPLE REVOLVING END-PIECES FOR PUSHRODS**

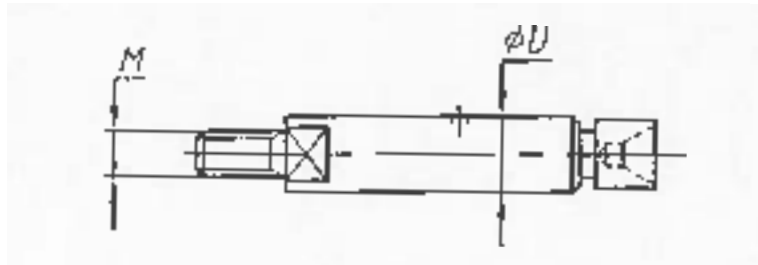

N° de code Bestell Nr Order Nr	Ø D mm	M mm	Prix Frs Preis Price
VO1150.0000	4,50	M 3,5	46.00
VO1151.0000	7	M 5	65.00
VO1152.0000	10	M 6	80.00
VO1153.0000	12	M 6	110.00
VO1154.0000	14	M 8	120.00
VO1155.0000	16	M 10	140.00
VO1156.0000	20	M 10	162.00
VO1157.0000	25	M 12	180.00
VO1158.0000	30	M 14	188.00
VO1159.0000	32	M 16	195.00
VO1160.0000	36	M 16	200.00

Autres dimensions sur demande
Weitere Masse auf verlangen
Other sizes on request



**BECS MÉTAL DUR TORNOS
HARTMETALL-NOCKEN FÜR TORNOS
TUNGSTEN CARBIDE TOES FOR TORNOS**

Becs pour outils verticaux
Nocken für senkrechte Werkzeuge
Toes for vertical tools

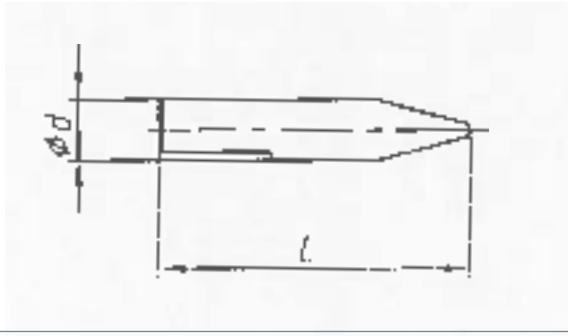

N° de code Bestell Nr Order Nr	Ø D mm	L mm	Prix Frs Preis Price
VO1191.0000	8	45	78.50
VO1193.0000	9	42	78.50
VO1197.0000	10	40	81.00
VO1199.0000	12	49	81.00
VO1201.0000	13	60	85.00

Becs pour poupée
Spindelstock-Nocken
Headstock toes

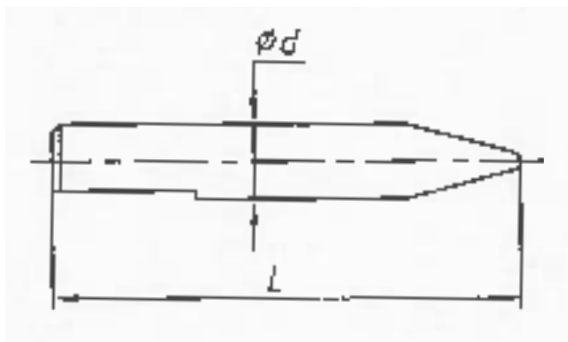

N° de code Bestell Nr Order Nr	Ø D mm	L mm	Prix Frs Preis Price
VO1202.0000	10	62	84.00
VO1204.0000	10	70	84.50
VO1206.0000	12	70	85.00
VO1208.0000	14	76	87.00
VO1210.0000	16	83	112.50
VO1212.0000	18	104	135.00
VO1214.0000	20	110	148.00

Becs pour bascule
Wippen-Nocken
Rocker toes

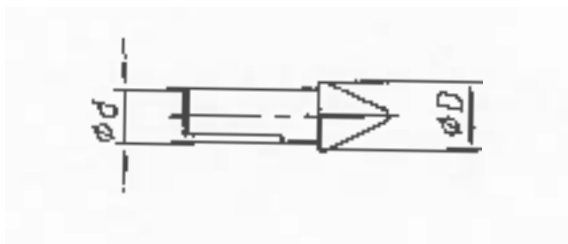

N° de code Bestell Nr Order Nr	Ø D mm	L mm	Prix Frs Preis Price
VO1217.0000	7	9	61.00
VO1219.0000	7	10	62.00
VO1221.0000	7	11	62.00
VO1223.0000	8	10	63.00
VO1225.0000	10	12	76.00



**BECS ACIER TORNOS
STAHL-NOCKEN FUER TORNOS
STEEL TOES FOR TORNOS**

Becs à galet pour poupées
Rollen-Nocken für Spindelstock
Roller-toes for headstock

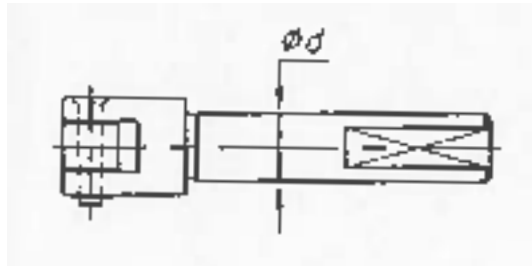

N° de code Bestell Nr Order Nr	Machines TORNOS TORNOS Maschinen TORNOS machines	Ø D mm	Prix Frs Preis Price
VO1230.0000	M-7	12	154.00
VO1232.0000	R-10	14	176.00
VO1234.0000	R-16 M-15	16	205.00
VO1236.0000	M-25 M-28	18	210.00
VO1238.0000	MR-28 MR-32	20	220.00

Galets et axes pour becs poupées
Rollen und Achsen für Spindel-Nocken
Rollers and axles for headstock toes

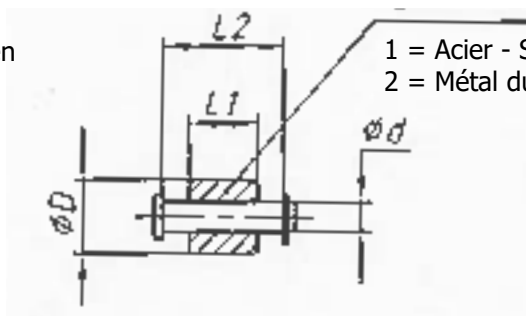

1 = Acier - Stahl - Steel
2 = Métal dur - Hartmetall - Tungsten Carbide

N° de code Bestell Nr Order Nr	Machines TORNOS TORNOS Maschinen TORNOS machines	Matière Material Materiel	Ø D mm	Ø d mm	L1 mm	L2 mm	Prix Frs Preis Price
VO1240.0000	M-7	1	10	4	9	14,50	48.00
VO1241.0000	M-7	2	10	4	9	14,50	
VO1242.0000	R-10	1	10	4	9	16,50	48.00
VO1243.0000	R-10	2	10	4	9	16,50	
VO1244.0000	R-16 M-15	1	14	6	12	19,50	58.00
VO1245.0000	R-16 M-15	2	14	6	12	19,50	
VO1246.0000	M-25 M-28	1	18	8	14	24	65.00
VO1247.0000	M-25 M-28	2	18	8	14	24	
VO1248.0000	MR-25 MR-32	1	18	8	14	24	68.00
VO1249.0000	MR-28 MR-32	2	18	8	14	24	



**PINCES POUR RAVITAILLEURS TORNOS 30 TUBES
KLEMMZANGEN FUER TORNOS STANGENLADER MIT 30 ROHREN
CLAMPING FINGERS FOR TORNOS BARFEEDERS WITH 30 TUBES**

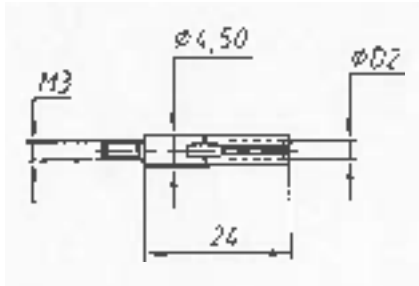

N° de code Bestell Nr Order Nr	Alésage Ø D2 mm Bohrung Bore	Ecart mm Abstand Distance	Prix Frs Preis Price
VO2100.0000	0,80 - 3,50	0,10 - 0,10	30.00

**PINCES POUR RAVITAILLEURS TORNOS 30 TUBES ET BARBOY 2-4
KLEMMZANGEN FUER TORNOS STANGENLADER MIT 30 ROHREN UND BARBOY 2-4
CLAMPING FINGERS FOR TORNOS BARFEEDERS WITH 30 TUBES AND BARBOY 2-4**

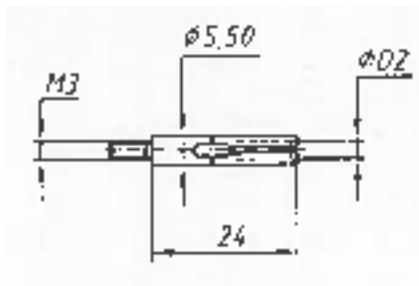

N° de code Bestell Nr Order Nr	Alésage Ø D2 mm Bohrung Bore	Ecart mm Abstand Distance	Prix Frs Preis Price
VO2101.0000	0,80 - 4,50	0,10 - 0,10	32.00

**PINCES POUR RAVITAILLEURS TORNOS 30 TUBES - SUPER - (VERTICAL) ET BARBOY 2-7
KLEMMZANGEN FUER TORNOS STANGENLADER MIT 30 ROHREN -SUPER (SENKRECHT) UND BARBOY 2-7
CLAMPING FINGERS FOR TORNOS BARFEEDERS WITH 30 TUBES -SUPER - (VERTICAL) AND BARBOY 2-7**

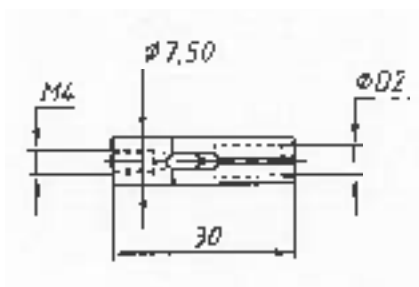

N° de code Bestell Nr Order Nr	Alésage Ø D2 mm Bohrung Bore	Ecart mm Abstand Distance	Prix Frs Preis Price
VO2102.0000	1 - 6	0,10 - 0,10	33.00

TYPE RFC

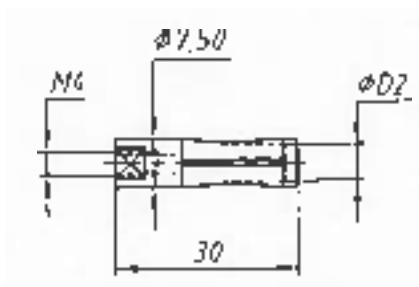

N° de code Bestell Nr Order Nr	Alésage Ø D2 mm Bohrung Bore	Ecart mm Abstand Distance	Prix Frs Preis Price
VO2103.0000	6 - 6,50	0,10 - 0,10	43.00



RG: 05

PINCES POUR RAVITAILLEURS TORNOS 24 TUBES - SUPER - (VERTICAL) ET BARBOY 2-7
KLEMMZANGEN FUER TORNOS STANGENLADER MIT 24 ROHREN -SUPER (SENKRECHT) UND BARBOY 2-7
CLAMPING FINGERS FOR TORNOS BARFEEDERS WITH 24 TUBES -SUPER - (VERTICAL) AND BARBOY 2-7

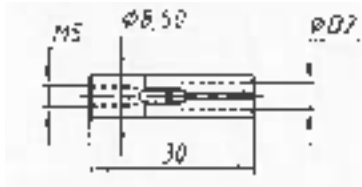

N° de code Bestell Nr Order Nr	Alésage Ø D2 mm Bohrung Bore	Ecart mm Abstand Distance	Prix Frs Preis Price
VO2104.0000	2 - 7	0,10 - 0,10	34.00

TYPE RFC

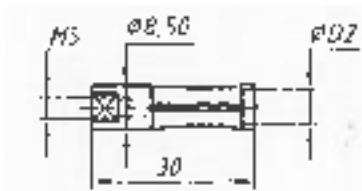

N° de code Bestell Nr Order Nr	Alésage Ø D2 mm Bohrung Bore	Ecart mm Abstand Distance	Prix Frs Preis Price
VO2105.0000	6,50 - 7,50	0,10 - 0,10	43.00

PINCES POUR RAVITAILLEURS TORNOS 24 TUBES - SUPER - (VERTICAL) ET BARBOY 7-9
KLEMMZANGEN FUER TORNOS STANGENLADER MIT 24 ROHREN -SUPER (SENKRECHT) UND BARBOY 7-9
CLAMPING FINGERS FOR TORNOS BARFEEDERS WITH 24 TUBES -SUPER - (VERTICAL) AND BARBOY 7-9

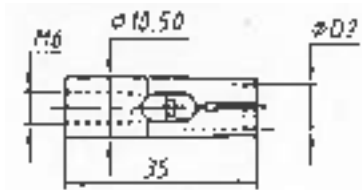

N° de code Bestell Nr Order Nr	Alésage Ø D2 mm Bohrung Bore	Ecart mm Abstand Distance	Prix Frs Preis Price
VO2106.0000	2 - 9	0,10 - 0,10	43.00

TYPE RFC

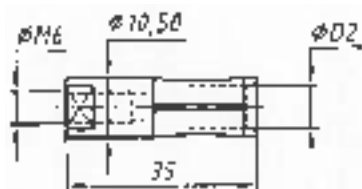

N° de code Bestell Nr Order Nr	Alésage Ø D2 mm Bohrung Bore	Ecart mm Abstand Distance	Prix Frs Preis Price
VO2107.0000	8,50 - 9,50	0,10 - 0,10	54.00

PINCES POUR RAVITAILLEURS TORNOS 24 TUBES - SUPER - (VERTICAL) ET BARBOY 7-11
KLEMMZANGEN FUER TORNOS STANGENLADER MIT 24 ROHREN -SUPER (SENKRECHT) UND BARBOY 7-11
CLAMPING FINGERS FOR TORNOS BARFEEDERS WITH 24 TUBES -SUPER - (VERTICAL) AND BARBOY 7-11

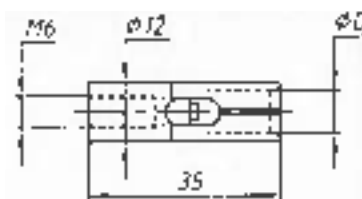

N° de code Bestell Nr Order Nr	Alésage Ø D2 mm Bohrung Bore	Ecart mm Abstand Distance	Prix Frs Preis Price
VO2108.0000	1,5 - 10,5	0,10 - 0,10	43.00

TYPE RFC

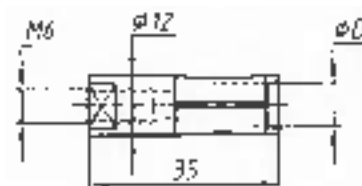

N° de code Bestell Nr Order Nr	Alésage Ø D2 mm Bohrung Bore	Ecart mm Abstand Distance	Prix Frs Preis Price
VO2109.0000	10 - 11	0,10 - 0,10	54.00



RG: 05

PINCES POUR RAVITAILLEURS TORNOS BARBOY 13-G
KLEMMZANGEN FUER TORNOS STANGENLADER BARBOY 13-G
CLAMPING FINGERS FOR TORNOS BARFEEDERS BARBOY 13-G

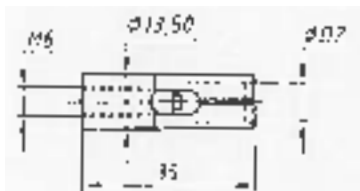

N° de code Bestell Nr Order Nr	Alésage Ø D2 mm Bohrung Bore	Ecart mm Abstand Distance	Prix Frs Preis Price
VO2110.0000	3 - 12	0,10 - 0,10	44.00

TYPE RFC

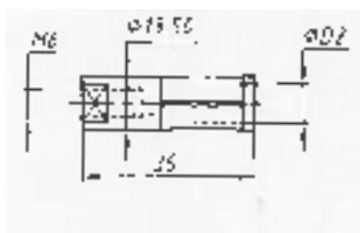

N° de code Bestell Nr Order Nr	Alésage Ø D2 mm Bohrung Bore	Ecart mm Abstand Distance	Prix Frs Preis Price
VO2111.0000	10 - 12,50	0,10 - 0,10	55.00

PINCES POUR RAVITAILLEURS TORNOS TORNOBAR 15
KLEMMZANGEN FUER TORNOS STANGENLADER TORNOBAR 15
CLAMPING FINGERS FOR TORNOS BARFEEDERS TORNOBAR 15

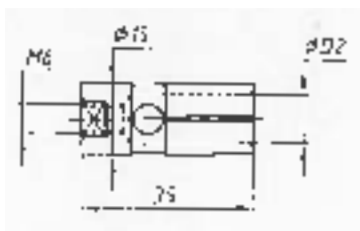

N° de code Bestell Nr Order Nr	Alésage Ø D2 mm Bohrung Bore	Ecart mm Abstand Distance	Prix Frs Preis Price
VO2112.0000	5 - 13	0,10 - 0,10	45.00

PINCES POUR RAVITAILLEURS TORNOS BARBOY 16,50
KLEMMZANGEN FUER TORNOS STANGENLADER BARBOY 16,50
CLAMPING FINGERS FOR TORNOS BARFEEDERS BARBOY 16,50

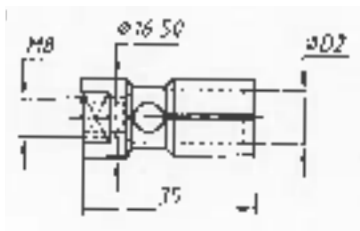

N° de code Bestell Nr Order Nr	Alésage Ø D2 mm Bohrung Bore	Ecart mm Abstand Distance	Prix Frs Preis Price
VO2113.0000	8 - 15	0,10 - 0,10	45.00

PINCES POUR RAVITAILLEURS TORNOS BARBOY 20,50
KLEMMZANGEN FUER TORNOS STANGENLADER BARBOY 20,50
CLAMPING FINGERS FOR TORNOS BARFEEDERS BARBOY 20,50

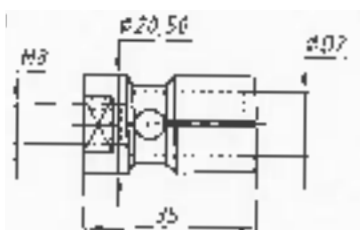

N° de code Bestell Nr Order Nr	Alésage Ø D2 mm Bohrung Bore	Ecart mm Abstand Distance	Prix Frs Preis Price
VO2114.0000	8 - 18	0,50 - 0,50	48.00



RG: 05

**PINCES POUR RAVITAILLEURS
KLEMMZANGEN FUER STANGENLADER
CLAMPING FINGERS FOR BARFEEDERS**

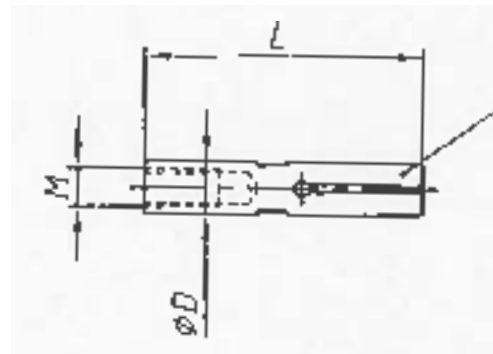

Contrôle KP

ROBOBAR TORNOS 5 / 7 mm

N° de code Bestell Nr Order Nr	Ø D mm	L mm	M mm	Alésage mm Bohrung Bore	Ecart mm Abstand Distance	Prix Frs Preis Price
VO2120.0000	5	37	M4	Ø 1,00 - 4,00	0,10 - 0,10	24.50
VO1121.0000	7	37	M5	Ø 1,00 - 6,00	0,10 - 0,10	25.00

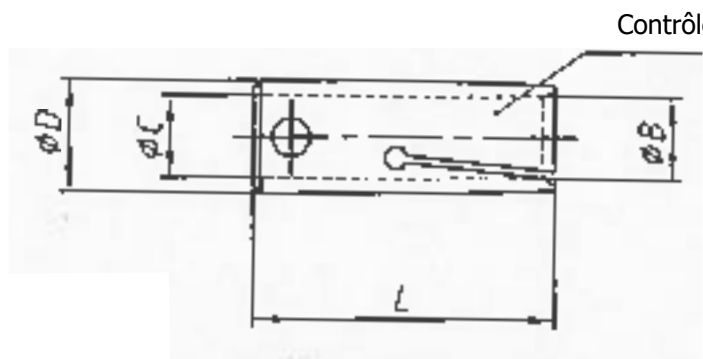

Contrôle KP

ROBOBAR TORNOS

N° de code Bestell Nr Order Nr	Ø D mm	Alésage mm Bohrung Bore	Ø C mm	L mm	Prix Frs Preis Price
VO2122.0000	10	1 - 9	7	40	29.50
VO2123.0000	12	1 - 10	8	40	30.00
VO2124.0000	15	1 - 13	11	40	34.00
VO2125.0000	20	4 - 19	14	65	39.50
VO2126.0000	25	4 - 24	20	65	42.00



**EMBOUS TOURNANTS POUR RAVITAILLEURS TORNOS
DREHENDE ENDSTUECKE FUER TORNOS STANGENLADER
REVOLVING END/PIECES FOR TORNOS BARFEEDERS**

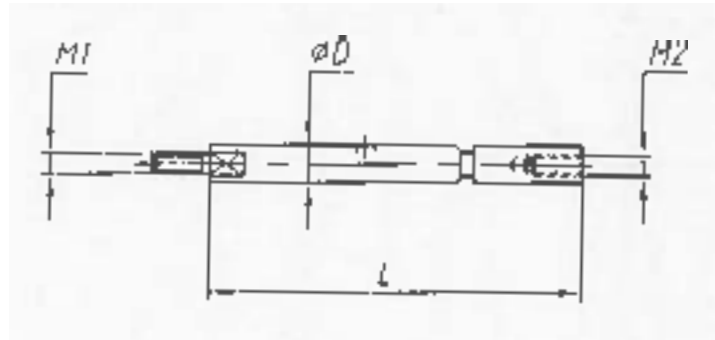

N° de code Bestell Nr Order Nr	Ø D mm	L mm	M1	M2	Prix Frs Preis Price
VO2140.0000	4,50	54,5	M3	M3	59.00
VO2141.0000	5,50	54,5	M3	M3	68.00

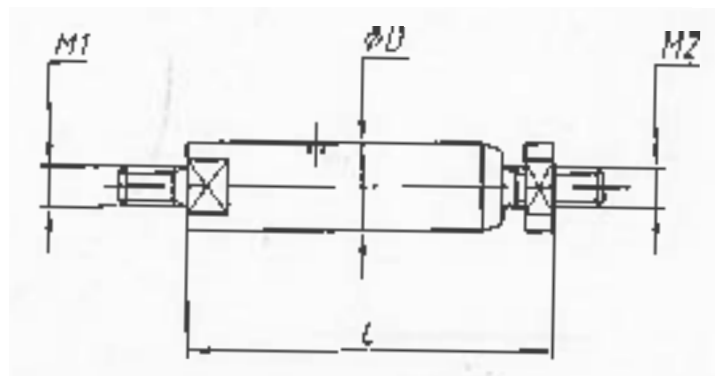

N° de code Bestell Nr Order Nr	Ø D mm	L mm	M1	M2	Prix Frs Preis Price
VO2142.0000	7	45,5	M5	M4	90.00
VO2143.0000	7,50	45,5	M5	M4	90.00
VO2144.0000	8,50	45,5	M5	M5	108.00
VO2145.0000	10,50	51	M6	M6	137.00
VO2146.0000	12	51	M6	M6	158.00
VO2147.0000	13-G	51	M6	M6	178.00
VO2148.0000	15	70	M7	M6	180.00
VO2149.0000	16	72	M7	M8	204.00
VO2150.0000	20	72	M7	M8	234.00



CABLES TELEFLEX POUR SUPER-TELEBAR TORNOS
TELEFLEX KABEL FUER TORNOR SUPER-TORNOS
TELEFLEX CABLES FOR TORNOS SUPER-TELEBAR

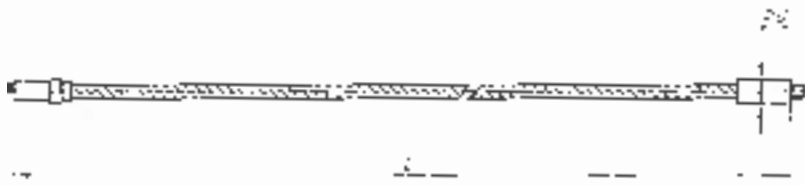

N° de code Bestell Nr Order Nr	Machines TORNOS TORNOR maschinen TORNOS machines	TELEFLEX	Ø D mm	L m	Prix Frs Preis Price
VO2160.0000	Super - Telebar	30 tubes	4,80/3,80	2	165.00
VO2161.0000	Super - Telebar	30 tubes	4,80/3,80	3	165.00
VO2162.0000	Super - Telebar	24 tubes	6,80/3,80	3	165.00
VO2163.0000	Super - Telebar	Vertical	6,80/4,80	3	220.00
VO2164.0000	Robobar SSF	24 tubes	6,80/3,80		180.00
VO2165.0000	Robobar SSF	40 tubes	4,80/3,80		180.00

RALLONGE
VERLAENGERUNG
EXTENSION

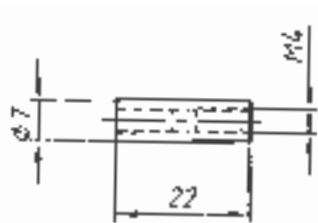

N° de code Bestell Nr Order Nr	Prix Frs Preis Price
VO2164.0000	15.00

POUSSETTE SUPER-TELEBAR TORNOS 30 / 24 TUBES
STOSS-STANGEN SUPER-TELEBAR TORNOS 30 / 24 ROHRE
PUSHROD SUPER-TELEBAR TORNOS 30 / 24 TUBES

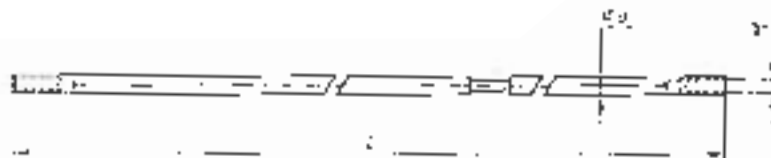

N° de code Bestell Nr Order Nr	Type Typ Type	Ø D mm	L mm	Prix Frs Preis Price
VO2170.0000	30 tubes	457	4,50	18.00
VO2171.0000	24 tubes	443	7	20.00



**MORS FIXES POUR SUPER-TELEBAR TORNOS
FESTE FLEMMBACKEN FÜR SUPER-TELEBAR LADER
FIXED JAWS SUPER-TELEBAR BARFEEDER**

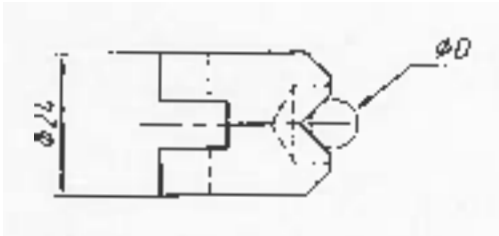

N° de code Bestell Nr Order Nr	Capacité Ø D mm Durchlass Capacity	Prix Frs Preis Price
VO2172.0809	Ø 0,8 - 0,9	84.00
VO2172.0910	Ø 0,9 - 1,0	84.00
VO2172.1011	Ø 1,0 - 1,1	84.00
VO2172.1112	Ø 1,1 - 1,2	84.00
VO2172.1213	Ø 1,2 - 1,3	84.00
VO2172.1314	Ø 1,3 - 1,4	84.00
VO2172.1415	Ø 1,4 - 1,5	84.00
VO2172.1516	Ø 1,5 - 1,6	84.00
VO2172.1617	Ø 1,6 - 1,7	84.00
VO2172.1718	Ø 1,7 - 1,8	84.00
VO2172.1819	Ø 1,8 - 1,9	84.00
VO2172.1920	Ø 1,9 - 2,0	84.00
VO2172.2021	Ø 2,0 - 2,1	84.00
VO2172.2122	Ø 2,1 - 2,2	84.00
VO2172.2223	Ø 2,2 - 2,3	84.00
VO2172.2324	Ø 2,3 - 2,4	84.00
VO2172.2425	Ø 2,4 - 2,5	84.00
VO2172.2526	Ø 2,5 - 2,6	84.00
VO2172.3031	Ø 3,0 - 3,1	84.00
VO2172.3536	Ø 3,5 - 3,6	84.00
VO2172.4041	Ø 4,0 - 4,1	84.00
VO2172.4546	Ø 4,5 - 4,6	84.00
VO2172.5051	Ø 5,0 - 5,1	84.00
VO2172.6061	Ø 6,0 - 6,1	84.00
VO2172.6364	Ø 6,3 - 6,4	84.00
VO2172.6566	Ø 6,5 - 6,6	84.00
VO2172.7071	Ø 7,0 - 7,1	84.00
VO2172.7076	Ø 7,5 - 7,6	84.00
VO2172.8081	Ø 8,0 - 8,1	84.00
VO2172.8586	Ø 8,5 - 8,6	84.00

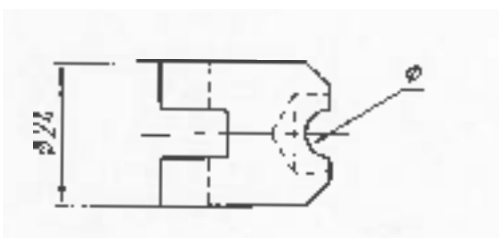

N° de code Bestell Nr Order Nr	Prix Frs Preis Price
VO2173.0000	85.00



RG: 05

EMBOUTS TOURNANTS POUR ROBOBAR TORNOS DREHENDE ENDSTUECKE FUER ROBOBAR TORNOS REVOLVING END-PIECES FOR ROBOBAR TORNOS

ROBOBAR 5,5

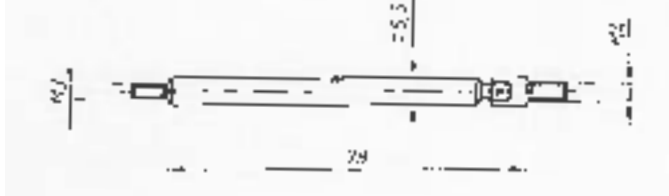

N° de code Bestell Nr Order Nr	Prix Frs Preis Price
VO2180.0000	69.00

ROBOBAR 7,5

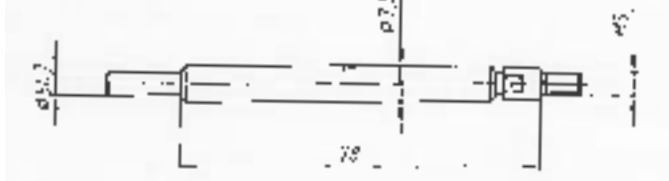

N° de code Bestell Nr Order Nr	Prix Frs Preis Price
VO2181.0000	90.00

ROBOBAR 10,5 - 36

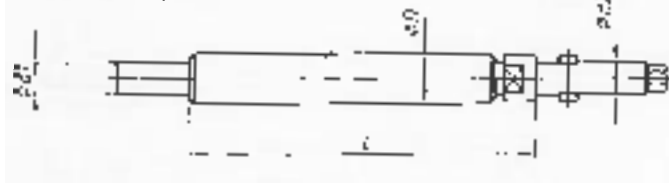

N° de code Bestell Nr Order Nr	Ø D mm	L mm	Ø d1 mm	Ø d2 mm	Prix Frs Preis Price
VO2182.0000	10,5	75	7	7	137.50
VO2183.0000	16	120	10	11	179.00
VO2183.5000	18	120	10	11	190.00
VO2184.0000	20,5	120	14	14	205.00
VO2185.0000	25	120	20	20	205.00
VO2186.0000	26	120	20	20	234.00
VO2187.0000	30	122	22	20	220.00
VO2188.0000	32	122	22	20	240.00
VO2189.0000	36	122	25	20	250.00

GOUPILLES

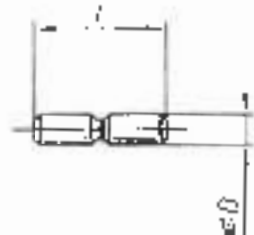

N° de code Bestell Nr Order Nr	Ø D mm	L mm	Prix Frs Preis Price
VO2182.10	4	10	7.50
VO2183.10	6	16	7.50
VO2183.60	6	18	7.50
VO2184.10	8	20	7.50
VO2185.10	8	25	7.50
VO2186.10	8	26	7.50



PINCES POUR TRANSPORTEURS TORNOS 14-OA
SPANNZANGEN FUER TORNOS TRANSPORTARM 14-OA
COLLETS FOR TORNOS TRANSPORT LEVER 14-OA

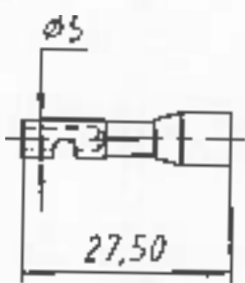

N° de code Bestell Nr Order Nr	Exécution Ausfuerung Make	Prix Frs Preis Price
VO2190.0000	A	13.50
VO2191.0000	B	22.00
VO2192.0000	C	156.00
VO2192.0001	D	186.00

PINCES POUR TRANSPORTEURS TORNOS 12-EA
SPANNZANGEN FUER TORNOS TRANSPORTARM 12-EA
COLLETS FOR TORNOS TRANSPORT LEVER 12-EA

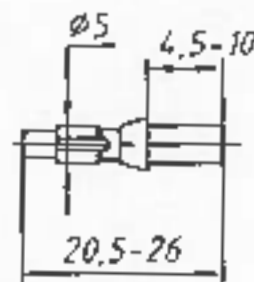

N° de code Bestell Nr Order Nr	Exécution Ausfuerung Make	Prix Frs Preis Price
VO2193.0000	A	13.50
VO2194.0000	B	22.00
VO2195.0000	C	156.00
VO2195.0001	D	186.00

PINCES POUR TRANSPORTEURS TORNOS 12-UB 12-JB 34-DA
SPANNZANGEN FUER TORNOS TRANSPORTARM 12-UB 12-JB 34-DA
COLLETS FOR TORNOS TRANSPORT LEVER 12-UB 12-JB 34-DA

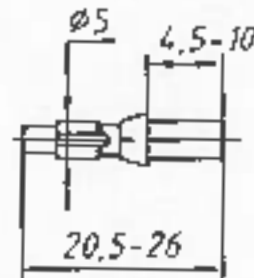

N° de code Bestell Nr Order Nr	Exécution Ausfuerung Make	Prix Frs Preis Price
VO2196.0000	A	13.50
VO2197.0000	B	22.00
VO2198.0000	C	156.00
VO2198.0001	D	186.00

Exécution A = Ebauche avec surépaisseur de 0,20

Ausfuerung A = Rohling mit Uebermass 0,20

Make A = Blank with oversize 0,20

Exécution B = Ebauche meulée à la cote

Ausfuerung B = Rohling auf Mass geschliffen

Make B = Blank milled at size

Exécution C = Pince terminée selon désir,
alésage simple

Ausfuerung C = Fertige Zange nach Wunsch,
einzige Bohrung

Make C = Finished collet as wanted,
single bore

Exécution D = Pince terminée selon désir,
alésage spécial

Ausfuerung D = Fertige Zange nach Wunsch,
spezielle Bohrung

Make D = Finished collet as wanted,
special bore



**PINCES POUR TRANSPORTEURS TORNOS 34-DA
SPANNZANGEN FUER TORNOS TRANSPORTARM 34-DA
COLLETS FOR TORNOS TRANSPORT LEVER 34-DA**

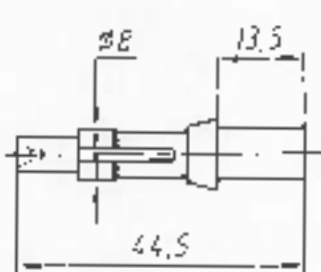

N° de code Bestell Nr Order Nr	Exécution Ausfuerung Make	Prix Frs Preis Price
VO2199.0000	A	15.00
VO2200.0000	B	22.00
VO2201.0000	C	166.00
VO2201.0001	D	196.00

**PINCES PRISE DE PIECE COMBINE 3 BR TORNOS 13-PB
AUFNAHME-ZANGEN FUER KOMB. 3-SP. APPARAT TORNOS 13-PB
PICK-UP COLLETS FOR COMB. 3-SP. ATTACHEMENT TORNOS 13-PB**

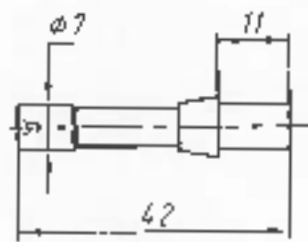

N° de code Bestell Nr Order Nr	Exécution Ausfuerung Make	Prix Frs Preis Price
VO2202.0000	A	15.00
VO2203.0000	B	22.00
VO2204.0000	C	166.00
VO2204.0001	D	196.00

**PINCES PRISE DE PIECE COMBINE 3 BR TORNOS 13-Y
AUFNAHME-ZANGEN FUER KOMB. 3-SP. APPARAT TORNOS 13-Y
PICK-UP COLLETS FOR COMB. 3-SP. ATTACHEMENT TORNOS 13-Y**

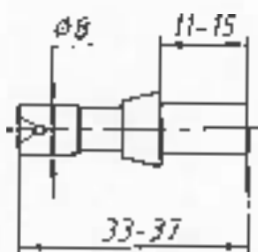

N° de code Bestell Nr Order Nr	Exécution Ausfuerung Make	Prix Frs Preis Price
VO2205.0000	A	15.00
VO2206.0000	B	22.00
VO2207.0000	C	166.00
VO2207.0001	D	196.00

Exécution A = Ebauche avec surépaisseur de 0,20

Ausfuerung A = Rohling mit Uebermass 0,20

Make A = Blank with oversize 0,20

Exécution B = Ebauche meulée à la cote

Ausfuerung B = Rohling auf Mass geschliffen

Make B = Blank milled at size

Exécution C = Pince terminée selon désir,
alésage simple

Ausfuerung C = Fertige Zange nach Wunsch,
einzige Bohrung

Make C = Finished collet as wanted,
single bore

Exécution D = Pince terminée selon désir,
alésage spécial

Ausfuerung D = Fertige Zange nach Wunsch,
spezielle Bohrung

Make D = Finished collet as wanted,
special bore



PINCES TRANSPORTEUR

Lors de la commande d'une pince transporteur, il est impératif de nous communiquer les renseignements suivants:

Type de pince (voir N° dans le tableau des pages suivantes) : _____

Exécution : Acier Métal dur

Extracteur : Oui Non

Appui de la pièce sur extracteur : Oui Non

Longueur de serrage de la pièce dans la pince : _____ Oui Non

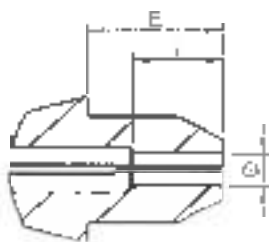

E= _____

i= _____

Ø= _____

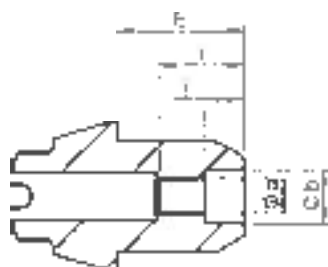

E= _____

i= _____

j= _____

Øa= _____

Øb= _____

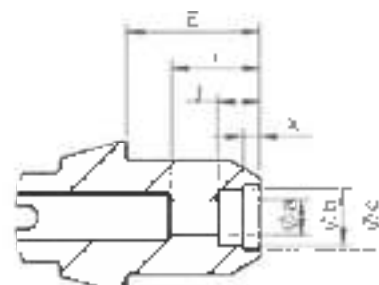

E= _____

i= _____

j= _____

k= _____

Øa= _____

Øb= _____

Øc= _____



PINCES POUR TRANSPORTEURS TORNOS 34-DA
SPANNZANGEN FUER TRANSPORTARM TORNORS 34-DA
COLLETS FOR TORNOS TRANSPORT LEVER 34-DA

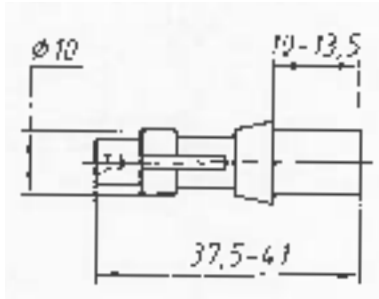

N° de code Bestell Nr Order Nr	Exécution Ausfuerung Make	Prix Frs Preis Price
VO2208.0000	A	22.00
VO2209.0000	B	34.00
VO2210.0000	C	166.00
VO2210.0001	D	196.00

PINCES POUR TRANSPORTEURS TORNOS 34-DA
SPANNZANGEN FUER TRANSPORTARM TORNORS 34-DA
COLLETS FOR TORNOS TRANSPORT LEVER 34-DA

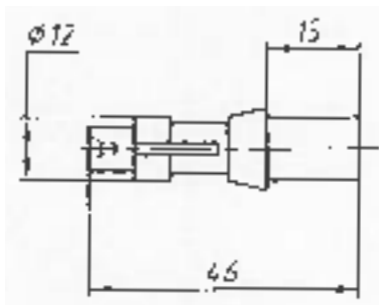

N° de code Bestell Nr Order Nr	Exécution Ausfuerung Make	Prix Frs Preis Price
VO2211.0000	A	22.00
VO2212.0000	B	34.00
VO2213.0000	C	166.00
VO2213.0001	D	196.00

PINCES POUR TRANSPORTEURS TORNOS 14-DA RR-20
SPANNZANGEN FUER TRANSPORTARM TORNOS 14-DA RR-20
COLLETS FOR TORNOS TRANSPORT LEVER 14-DA RR-20

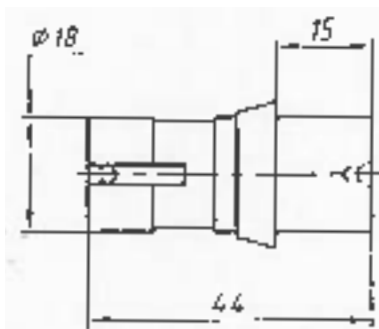

N° de code Bestell Nr Order Nr	Exécution Ausfuerung Make	Prix Frs Preis Price
VO2214.0000	A	35.00
VO2215.0000	B	55.00
VO2216.0000	C	205.00
VO2216.0001	D	240.00

Exécution A = Ebauche avec surépaisseur de 0,20

Ausfuerung A = Rohling mit Uebermass 0,20

Make A = Blank with oversize 0,20

Exécution B = Ebauche meulée à la cote

Ausfuerung B = Rohling auf Mass geschliffen

Make B = Blank milled at size

Exécution C = Pince terminée selon désir,
alésage simple

Ausfuerung C = Fertige Zange nach Wunsch,
einzige Bohrung

Make C = Finished collet as wanted,
single bore

Exécution D = Pince terminée selon désir,
alésage spécial

Ausfuerung D = Fertige Zange nach Wunsch,
spezielle Bohrung

Make D = Finished collet as wanted,
special bore



PIECES POUR COMBINE 3 BR TORNOS 12-U ET 13-Y
TEILE FUER KOMBINIERTEN 3-SPINDLIGEN APPARAT TORNORS 12-U UND 13-Y
PARTS FOR COMBINED 3-SPINDLE ATTACHEMENT TORNOS 12-U AND 13-Y

Pince B-6
 Spannzange B-6
 Collet B-6

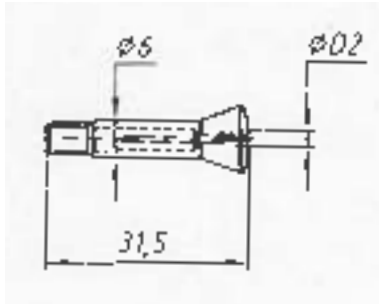

N° de code Bestell Nr Order Nr	Alésage Ø D2 mm Bohrung Bore	Ecart mm Abstand Distance	Prix Frs Preis Price
VO2220.0000	0,50 - 0,90	0,10 - 010	105.00
VO2220.0001	1,00 - 1,40	0,10 - 010	100.00
VO2220.0002	1,50 - 2,90	0,10 - 010	90.00
VO2220.0003	3,10 - 5,90	0,10 - 010	80.00
VO2220.0004	6,10 - 7,00	0,10 - 010	80.00
VO2221.0000	3,00 - 6,00	0,50 - 050	80.00

Pince B-8
 Spannzange B-8
 Collet B-8

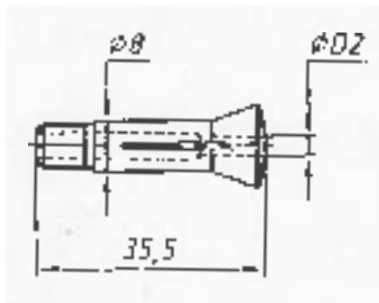

N° de code Bestell Nr Order Nr	Alésage Ø D2 mm Bohrung Bore	Ecart mm Abstand Distance	Prix Frs Preis Price
VO2222.0000	0,50 - 0,90	0,10 - 010	110.00
VO2222.0001	1,00 - 1,40	0,10 - 010	102.00
VO2222.0002	1,50 - 2,90	0,10 - 010	85.00
VO2222.0003	3,00 - 8,00	0,10 - 010	75.00
VO2223.0000	3,00 - 8,00	0,50 - 050	

Clé pour pince B-6
 Schlüssel für Zange B-6
 Wrench for collet B-6

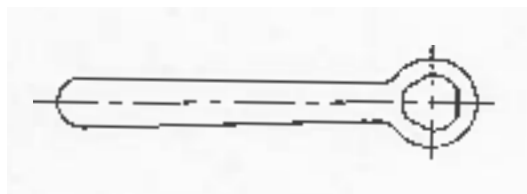

N° de code Bestell Nr Order Nr	Prix Frs Preis Price
VO2226.0000	12.00

Clé pour pince B-8
 Schlüssel für Zange B-8
 Wrench for collet B-8

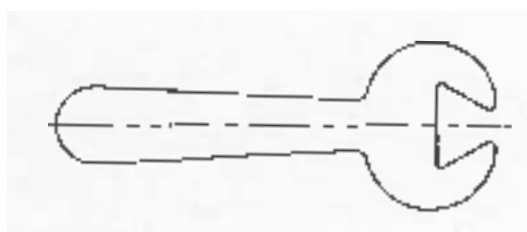

N° de code Bestell Nr Order Nr	Prix Frs Preis Price
VO2227.0000	28.00



PIECES POUR COMBINES 3 BR TORNOS 12-U ET 13-Y
TEILE FUER KOMBINIERTEN 3-SPINDLIGEN APPARAT TORNOS 12-U UND 13-Y
PARTS FOR COMBINED 3-SPINDLE ATTACHEMENT TORNOS 12-U AND 13-Y

Rallonge F-8 pour pince B-6
 Verlaengerung F-8 für Zange B-6
 Extension F-8 for collet B-6

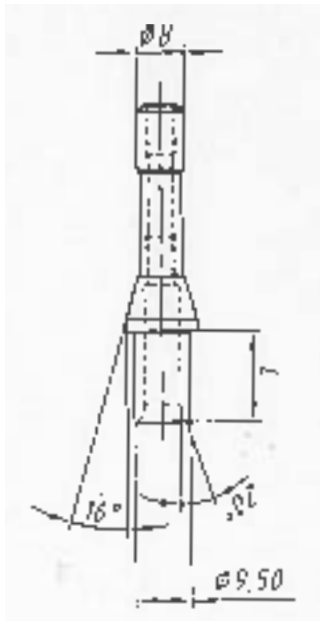

N° de code Bestell Nr Order Nr	L mm	Prix Frs Preis Price
VO2228.1000	10	180.00
VO2228.1250	12,50	180.00
VO2228.1500	15	180.00
VO2228.1750	17,50	180.00
VO2228.2000	20	182.00
VO2228.2250	22,50	182.00
VO2228.2500	25	182.00
VO2228.2750	27,50	182.00
VO2228.3000	30	185.00
VO2228.3250	32,50	185.00
VO2228.3500	35	185.00
VO2228.4000	40	188.00
VO2228.4200	42	188.00

CÔNES
KEGEL
CONES

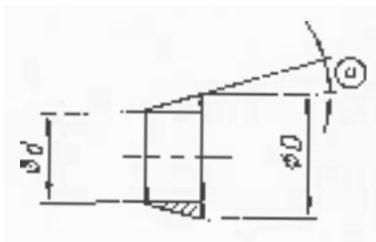

N° de code Bestell Nr Order Nr	Type Typ Type	Ø d mm	Ø D mm	Alpha	Prix Frs Preis Price
VO2229.0710	F7 15°	7	10,5	15°	25.00
VO2229.0711	F7 16°	7	11	16°	25.00
VO2229.0812	F8 16°	8	12	16°	25.00
VO2229.1016	F10 20°	10	16	20°	27.00
VO2229.1218	F12 16°	12	18	16°	28.00
VO2229.1521	F15 16°	15	21	16°	29.00
VO2229.1622	F16 15°	16	22	15°	33.00
VO2229.1621	F16 16°	16	21	16°	33.00
VO2229.2035	F20 15°	20	35	15°	35.00



POUSSETTES TELEBAR TORNOS 9 ET 12 TUBES
STOSS-STANGEN FUER TORNOS TELEBAR MIT 9 UND 12 ROHREN
PUSHRODS FOR TORNOS TELEBAR WITH 9 AND 12 TUBES

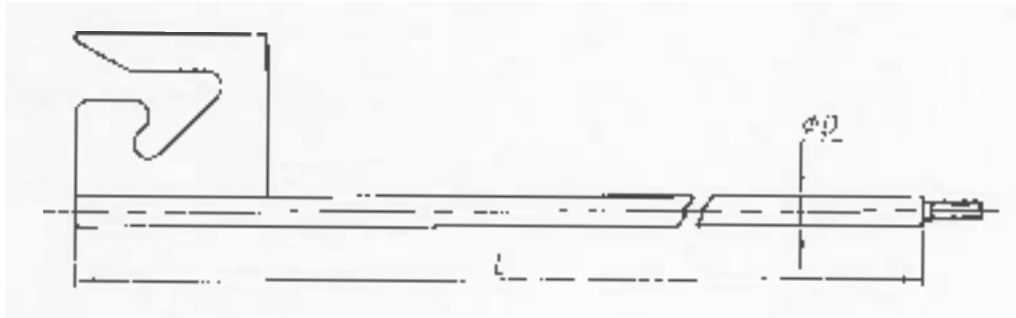

N° de code Bestell Nr Order Nr	Machine TORNOS TORNOS Maschinen TORNOS machines	Type Typ Type	Ø D mm	L mm	Prix Frs Preis Price
VO2230.0000	M-4	12 Tubes	4,50	467	26.00
VO2231.0000	M-7	12 Tubes	5	570	27.00
VO2232.0000	R-10	9 Tubes	7	695	32.00
VO2233.0000	M-7	9 Tubes	7	570	33.00

ENTRETOISES ET CROCHETS TELEBAR TORNOS 9 ET 12 TUBES
ZWISCHENSTUECKE UND HAKEN FUER TORNOS TELEBAR MIT 9 UND 12 ROHREN
DISTANCE PIECES AND HOOKS FOR TORNOS TELEBAR WITH 9 AND 12 TUBES

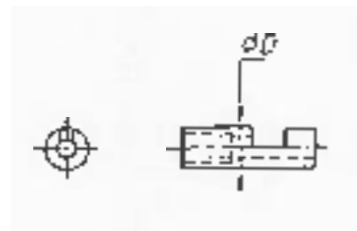
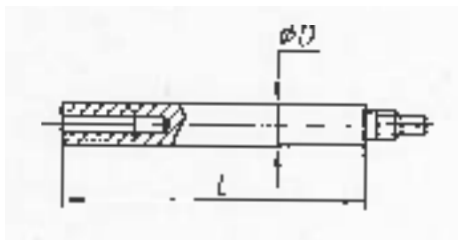

N° de code Bestell Nr Order Nr	Ø D mm	L mm	Prix Frs Preis Price
VO2240.4530	4,50	30	13.00
VO2241.4585	4,50	85	13.50
VO2241.4511	4,50	110	14.00
VO2242.5040	5	40	13.00
VO2243.5070	5	70	13.50
VO2244.5110	5	110	14.00
VO2245.7050	7	50	16.00
VO2246.7110	7	110	17.00

N° de code Bestell Nr Order Nr	Ø D mm	Prix Frs Preis Price
VO2250.0000	4,50	13.00
VO2251.0000	5	14.00
VO2252.0000	7	17.00



BARETTES ENTRAÎNEUSES

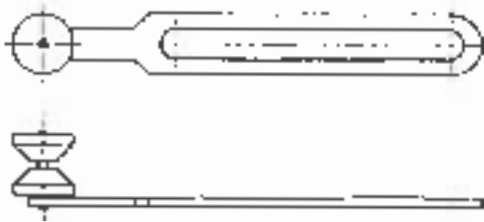

N° de code	Prix Frs
Bestell Nr	Preis
Order Nr	Price
VO2261.0000	35.00

ATTACHES TELEBAR TORNOS M-4 12 TUBES CORP 4,50 KLEMMZANGEN FUER TORNOS TELEBAR M-4 MIT 12 ROHREN SCHAFT 4,50 CLAMPING FINGERS FOR TORNOS TELEBAR M-4 WITH 12 TUBES SCHANK 4,50

SERIE 2270

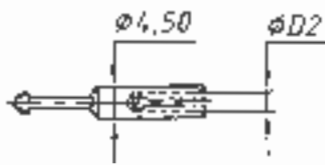

N° de code	Alésage Ø D2 mm	Ecart mm	Prix Frs
Bestell Nr	Bohrung	Abstand	Preis
Order Nr	Bore	Distance	Price
VO2271.0000	0,90 - 3,50	0,10 - 010	13.00

ATTACHES TELEBAR TORNOS M-7 12 TUBES CORP 5,50 KLEMMZANGEN FUER TORNOS TELEBAR M-7 MIT 12 ROHREN SCHAFT 5,50 CLAMPING FINGERS FOR TORNOS TELEBAR M-7 WITH 12 TUBES SCHANK 5,50

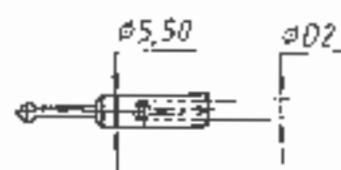

N° de code	Alésage Ø D2 mm	Ecart mm	Prix Frs
Bestell Nr	Bohrung	Abstand	Preis
Order Nr	Bore	Distance	Price
VO2273.0000	0,90 - 4,50	0,10 - 010	13.00

ATTACHES TELEBAR TORNOS M-7 12 TUBES CORP 5,50 KLEMMZANGEN FUER TORNOS TELEBAR M-7 MIT 12 ROHREN SCHAFT 5,50 CLAMPING FINGERS FOR TORNOS TELEBAR M-7 WITH 12 TUBES SCHANK 5,50

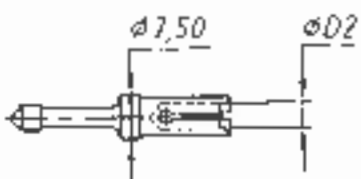

N° de code	Alésage Ø D2 mm	Ecart mm	Prix Frs
Bestell Nr	Bohrung	Abstand	Preis
Order Nr	Bore	Distance	Price
VO2275.0000	1,50 - 6,50	0,10 - 010	18.00



BECS ACIER ET MÉTAL DUR TORNOS STAHL UND HARTMETAL-NOCKEN TORNOS STEEL AND T.C. TOES FOR TORNOS

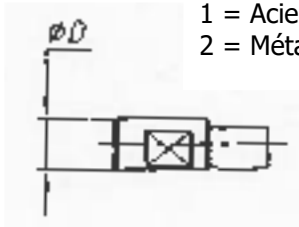

1 = Acier - Stahl - Steel
2 = Métal dur - Hartmetall - Tungsten Carbide

Becs d'avance - Vorschubnocken - Feed toes

N° de code Bestell Nr Order Nr	Appareil Apparat Attachment	Machines TORNOS TORNOS Maschinen TORNOS machines	Matière Material Material	Ø D mm	Prix Frs Preis Price
VO2300.0001	13-PB	M-4	1	6	25.00
VO2300.0002	13-PB	M-4	2	6	48.00
VO2300.0003	13-Y	M-7 R-10	1	8	28.00
VO2300.0004	13-Y	M-7 R-10	2	8	48.00
VO2300.0005	12-CA	R-16 RR-20	1	10	29.50
VO2300.0006	12-CA	R-16 RR-20	2	10	55.00
VO2300.0007		MR-32	1	12	37.00
VO2300.0008		MR-32	2	12	65.00

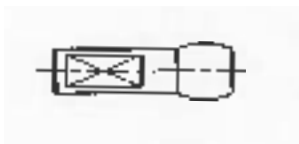

Becs d'embrayage 13-Y
Einschaltnocken 13-Y
Engaging toes 13-Y

N° de code Bestell Nr Order Nr	Matière Material Material	Prix Frs Preis Price
VO2302.0000	1	
VO2303.0000	2	

Becs de levier cliquet 13-Y
Nocken des Klink-Hebels 13-Y
Toes of ratchet lever 13-Y

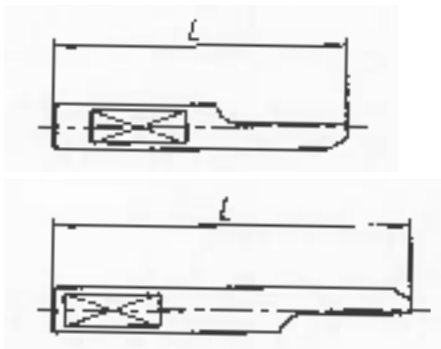

N° de code Bestell Nr Order Nr	Matière Material Material	L mm	Prix Frs Preis Price
VO2360.0000	2	46	44.00
VO2361.0000	2	55	45.00
VO2362.0000	1	46	25.00
VO2363.0000	1	55	27.00

Becs levier d'embrayage 13-Y
Nocken des Kupplungs-Hebels 13-Y
Toes of engaging lever 13-Y



**BECS DE NOMBRAGE A TOUCHE METAL DUR TORNOS
SCHALTNOCKEN MIT HARTMETALL-PLAETTCHEN
INDEXING TOES WITH T.C. PADS**

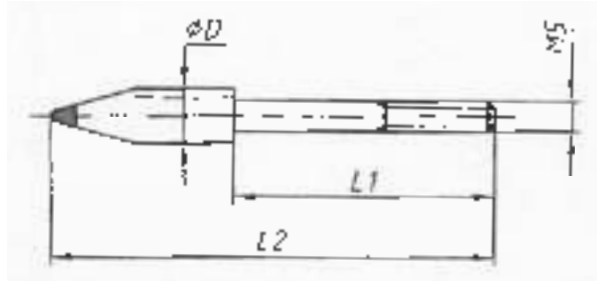

N° de code Bestell Nr Order Nr	Appareil Apparat Attachment	Ø D mm	L 1 mm	L 2 mm	Prix Frs Preis Price
VO2320.0000	RD-7397	9	27	60	75.00
VO2321.0000	12-X / 14-R	9	43	70	

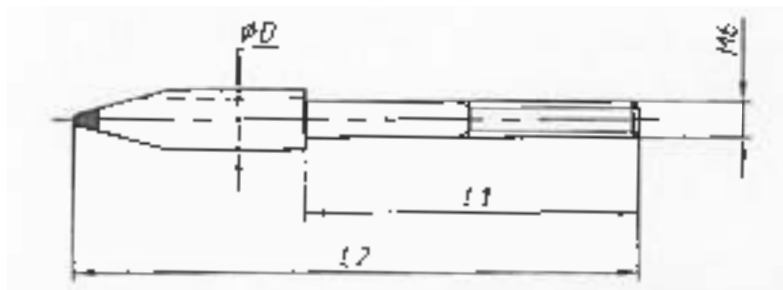

N° de code Bestell Nr Order Nr	Appareil Apparat Attachment	Ø D mm	L 1 mm	L 2 mm	Prix Frs Preis Price
VO2323.0000	13-Y	10	45	82	80.00
VO2324.0000	12-JB	10	48	86	80.00
VO2325.0000	12-U / 13-Y	10	55	93	85.00

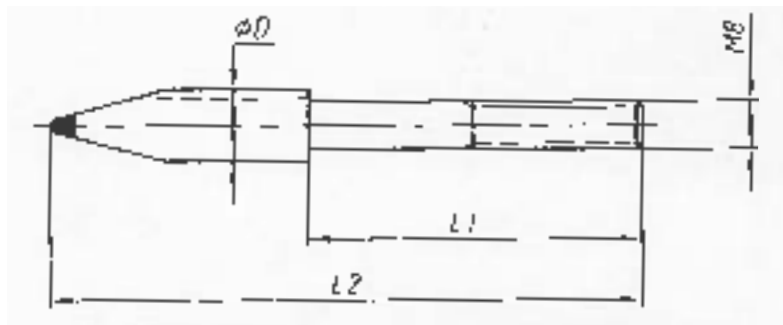

N° de code Bestell Nr Order Nr	Transporteur Transporthebel Transporter	Ø D mm	L 1 mm	L 2 mm	Prix Frs Preis Price
VO2326.0000	M-15	12	55	97	95.00



**BECS DE NOMBRAGE A GALET POUR APPAREILS TORNOS
SCHALT-NOCKEN MIT ROLLE FUER TORNOS APPARATE
INDEXING TOES WITH ROLLERS FOR TORNOS ATTACHMENTS**

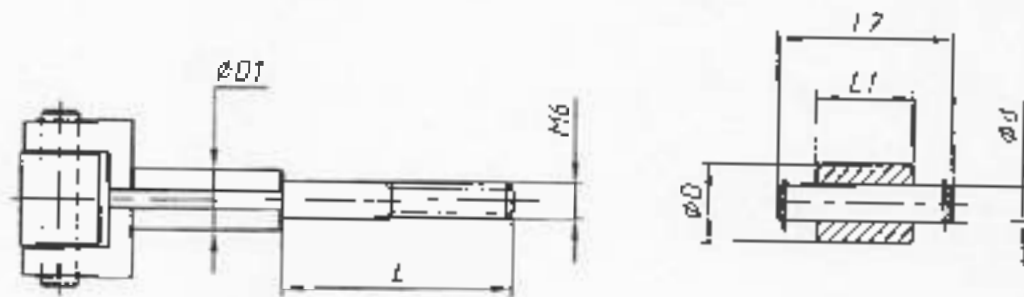

Bec pour MF-273
Nocken für MF-273
Toe for MF-273

N° de code Bestell Nr Order Nr	Appareil Apparat Attachment	$\varnothing D1$ mm	L mm	Prix Frs Preis Price
VO2331.0000	MF-273	10	38	168.00

Galet
Rolle
Roller

N° de code Bestell Nr Order Nr	Appareil Apparat Attachment	$\varnothing D$ mm	$\varnothing d$ mm	L1 mm	L2 mm	Prix Frs Preis Price
VO2332.0000	MF-273	13	6	16	29	53.00

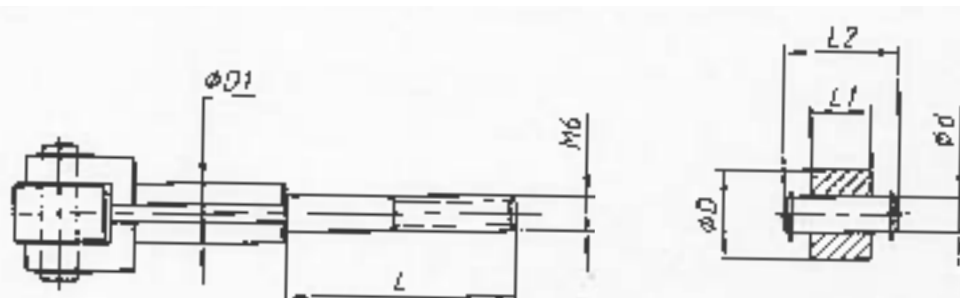

Bec pour 13-Y
Nocken für 13-Y
Toe for 13-Y

N° de code Bestell Nr Order Nr	Appareil Apparat Attachment	$\varnothing D1$ mm	L mm	Prix Frs Preis Price
VO2333.0000	13-Y	10	38	154.00

Galet
Rolle
Roller

N° de code Bestell Nr Order Nr	Appareil Apparat Attachment	$\varnothing D$ mm	$\varnothing d$ mm	L1 mm	L2 mm	Prix Frs Preis Price
VO2334.0000	13-Y	15	6	10	23	54.00



**BECS DE NOMBRAGE A GALET POUR APPAREILS TORNOS
SCHALT-NOCKEN MIT ROLLE FUER TORNOS APPARATE
INDEXING TOES WITH ROLLERS FOR TORNOS ATTACHMENTS**

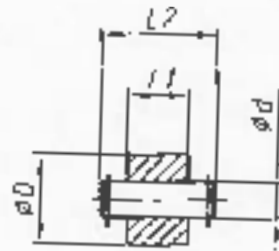
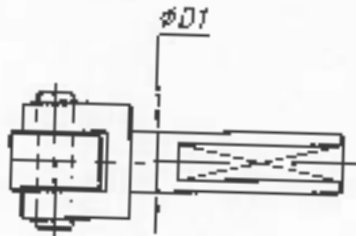

Bec pour 13-Y
Nocken für 13-Y
Toe for 13-Y

N° de code Bestell Nr Order Nr	Appareil Apparat Attachment	Ø D1 mm	Prix Frs Preis Price
VO2333.0010	13-Y	10	127.00

Galet
Rolle
Roller

N° de code Bestell Nr Order Nr	Appareil Apparat Attachment	Ø D mm	Ø d mm	L1 mm	L2 mm	Prix Frs Preis Price
VO2334.0000	13-Y	15	6	10	23	54.00

**BECS DE NOMBRAGE A TOUCHE POUR APPAREILS TORNOS
SCHALT-NOCKEN FUER TORNOS APPARATE
INDEXING TOES FOR TORNOS ATTACHMENTS**

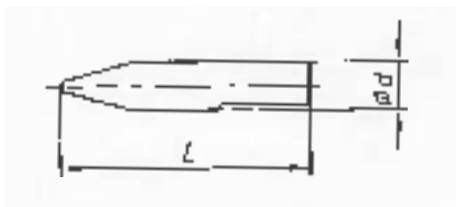

N° de code Bestell Nr Order Nr	Ø d mm	L mm	Prix Frs Preis Price
VO2333.0020	10	55	58.00



**BECS DE NOMBRAGE A GALET POUR APPAREILS TORNOS
SCHALT-NOCKEN MIT ROLLE FUER TORNOS APPARATE
INDEXING TOES WITH ROLLERS FOR TORNOS ATTACHMENTS**

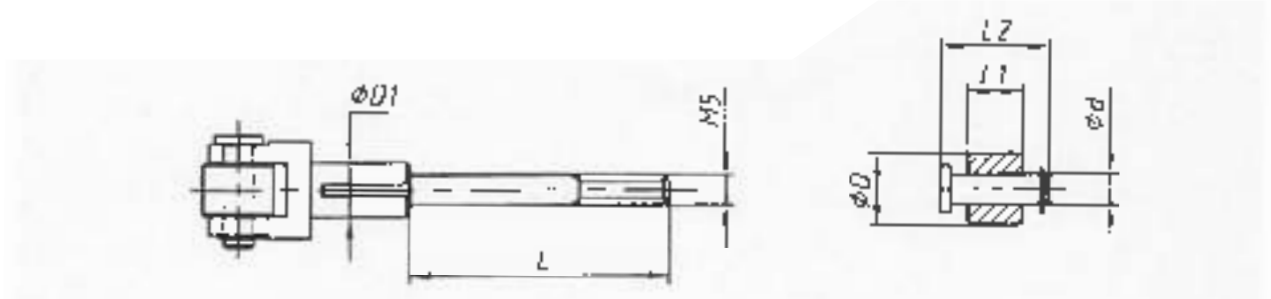

Bec pour 12-X 12-VB 12-CA
Nocken für 12-X 12-VB 12-CA
Toe for 12-X 12-VB 12-CA

N° de code Bestell Nr Order Nr	Appareil Apparat Attachment	Ø D1 mm	L mm	Prix Frs Preis Price
	M-4 12-X			
VO2335.0000	M-7 12-VB	9	43	154.00
	M-7 12-CA			

Galet
Rolle
Roller

N° de code Bestell Nr Order Nr	Appareil Apparat Attachment	Ø D mm	Ø d mm	L1 mm	L2 mm	Prix Frs Preis Price
	M-4 12-X					
VO2336.0000	M-7 12-VB	12	5	9	18	44.00
	M-7 12-CA					

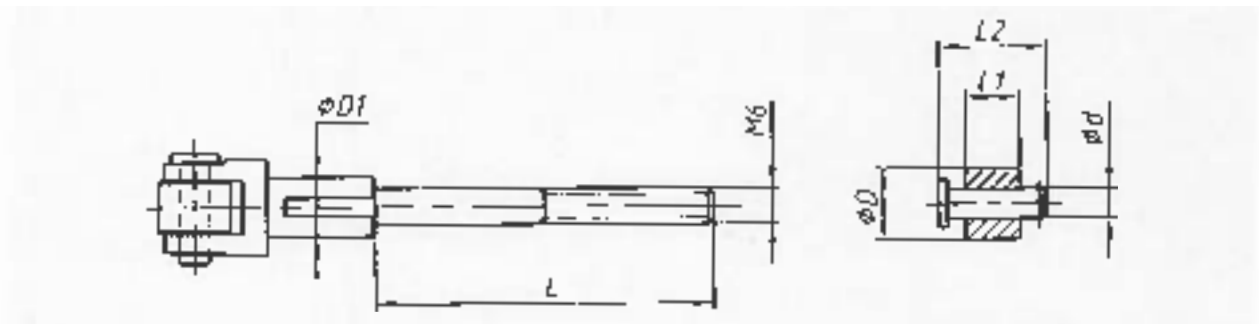

Bec pour 34-DA
Nocken für 34-DA
Toe for 34-DA

N° de code Bestell Nr Order Nr	Appareil Apparat Attachment	Ø D1 mm	L mm	Prix Frs Preis Price
VO2337.0000	34-DA	10	56	226.50

Galet
Rolle
Roller

N° de code Bestell Nr Order Nr	Appareil Apparat Attachment	Ø D mm	Ø d mm	L1 mm	L2 mm	Prix Frs Preis Price
VO2338.0000	34-DA	12	5	9	18	44.00



TOLE D'APPUI POUR FENDEUR UNIVRSEL TORNOS 34-DA
ABSTUETZBLECH FUER UNIVERSAL-SCHLITZAPPARAT TORNOS 34-D
SUPPORT SHEETING FOR UNIVERSAL SLOTTING ATTACHMENT TORNOS 34-D

N° de code	Prix
Bestell Nr	Preis
Order Nr	Price
VO2338.0007	35.00

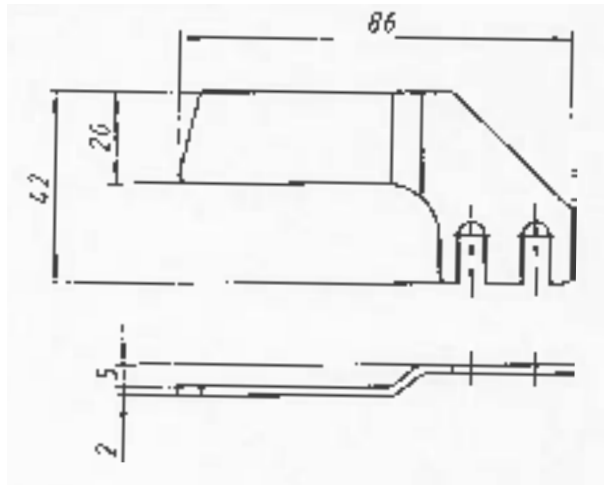

BECS D'APPAREIL
NOCKEN FUR APPARAT
TOES FOR ATTACHMENT

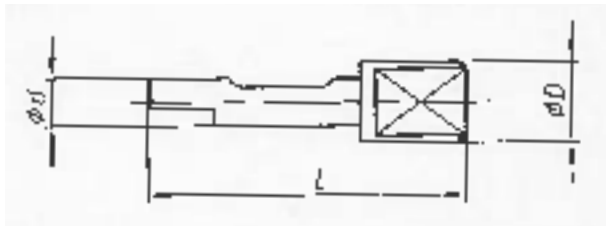

- 1 = Acier - Stahl - Steel
- 2 = Métal dur - Hartmetall - Tungsten Carbide

N° de code Bestell Nr Order Nr	Machines TORNOS TORNOS Maschinen TORNOS machines	Matière Material Materiel	Ø D mm	Ø d mm	L1 mm	L2 mm	Prix Frs Preis Price
VO2338.0001	34-BA	M-4	1	10	7	37	48.00
VO2338.0002	34-BA	M-4	2	10	7	37	80.00
VO2338.0003	34-DA	M-7 R-10	1	13,5	8	52,5	48.00
VO2338.0004	34-DA	M-7 R-10	2	13,5	8	52,5	82.00
VO2338.0005	14-BA	R-16 RR-20	1	15,5	10	55	55.00
VO2338.0006	14-BA	R-16 RR-20	2	15,5	10	55	90.00

Bec pour 32-AA
 Nocken für 32-AA
 Toes for 32-AA

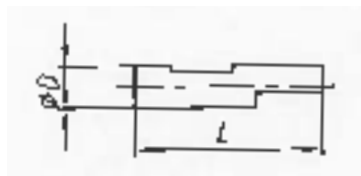

N° de code Bestell Nr Order Nr	Machines TORNOS TORNOS Maschinen TORNOS machines	Matière Material Materiel	Ø D mm	Ø d mm	L mm	Prix Frs Preis Price
VO2338.0010	32-AA	M-7	2	7	31	55.00



**BECS DE NOMBRAGE À GALET POUR APPAREILS TORNOS
SCHALT-NOCKEN MIT ROLLE FUER TORNOS APPARAT
INDEXING TOES WITH ROLLER FOR TORNOS ATTACHMENT**

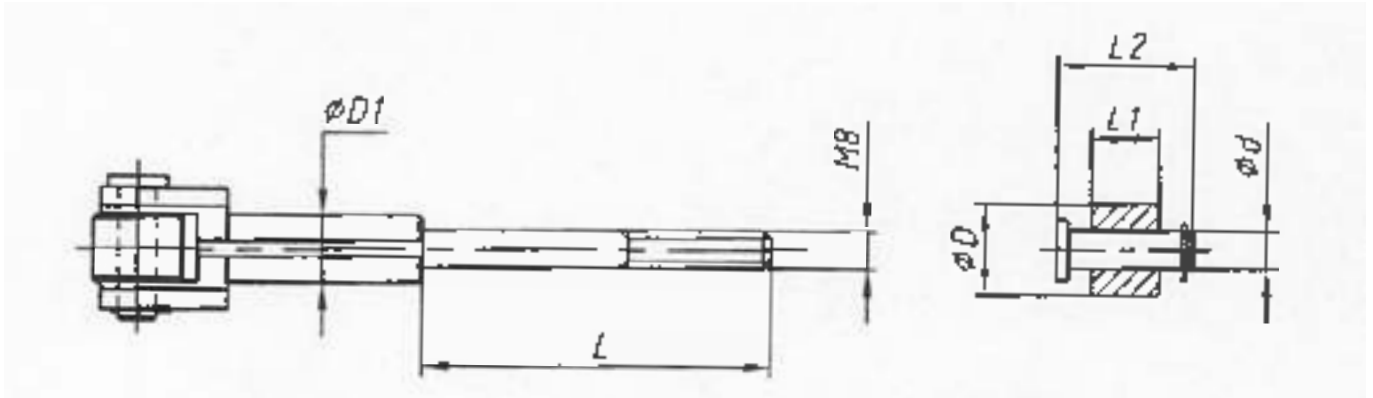

Bec pour combiné R-16 RR-20
Nocken für Kombinierten App. R-16 RR-20
Toe for combined attachment R-16 RR-20

N° de code Bestell Nr Order Nr	Appareil Apparat Attachment	Ø D1 mm	L mm	Prix Frs Preis Price
VO2339.0000	13-CA	14	60	174.00

Galet
Rolle
Roller

N° de code Bestell Nr Order Nr	Appareil Apparat Attachment	Ø D mm	Ø d mm	L1 mm	L2 mm	Prix Frs Preis Price
VO2340.0000	13-CA	18	7	12	26	53.00



BECS ACIER ET MÉTAL DUR TORNOS
NOCKEN AUS STAHL UND HARDMETAL FUER TORNOS
STEEL AND TUNGSTEN CARBIDE TOES FOR TORNOS

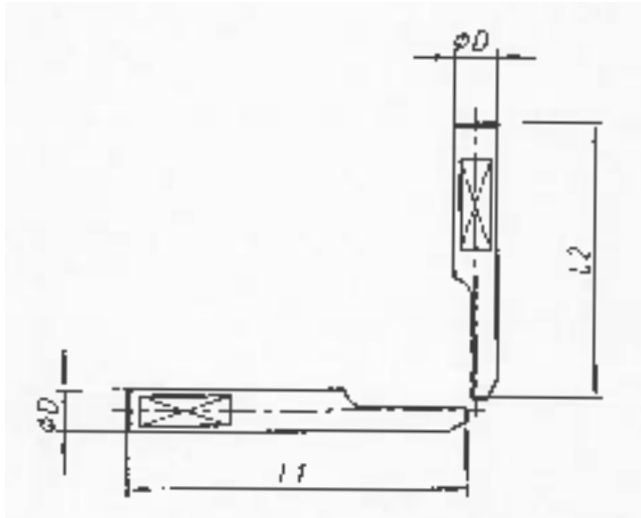

Bec levier d'embrayage
 Nocken des Kupplungs-Hebels
 Toe of engaging lever

Bec du levier cliquet
 Nocken des Klink-Hebels
 Toe of ratchet lever

- 1 = Acier - Stahl - Steel
 2 = Métal dur - Hartmetall - Tungsten Carbide

N° de code Bestell Nr Order Nr	Appareil Apparat Attachment	Ø D mm	L1 mm	L2 mm	Matière Material Material	Prix Frs Preis Price
VO2350.0000	Tarauteur M-4	5	30		2	42.00
VO2351.0000	Tarauteur M-4	5		33	2	42.00
VO2352.0000	Combiné M-4	6	37		2	42.00
VO2353.0000	Combiné M-4	6		45	2	42.00
VO2354.0000	13-G	6	40		2	42.00
VO2355.0000	13-G	6		46	2	42.00
VO2356.0000	14-D	6	47		2	42.00
VO2357.0000	14-D	6		54	2	42.00
VO2358.0000	13-OA	7	33		2	42.00
VO2359.0000	13-OA	7		47	2	42.00
VO2360.0000	13-Y	7	46		2	42.00
VO2361.0000	13-Y	7		55	2	42.00
VO2362.0000	13-Y	7	46		1	28.00
VO2363.0000	13-Y	7		55	1	28.00



PIÈCES POUR COMBINÉ 3 BR TORNOS 12-U ET 13-Y
TEILE FUER KOMBINIERTEN 3-SP. APPARAT TORNOS 12-U UND 13-Y
PARTS FOR COMBINED 3-SP ATTACHMENT TORNOS 12-U ET 13-Y

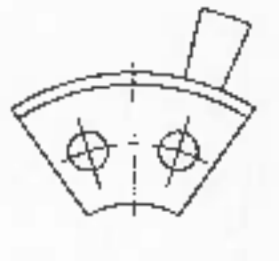

Bec de sûreté P126
 Sicherheitsnocken P126
 Safety toe P126

N° de code	Prix	Frs
Bestell Nr	Preis	
Order Nr	Price	
VO2370.0000		



Taquets du bec P133
 Nocken P133
 Toe P133

N° de code	Prix	Frs
Bestell Nr	Preis	
Order Nr	Price	
VO2401.0000	13.50	

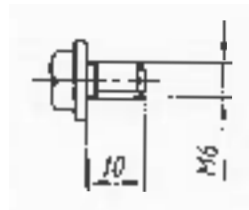

Vis du bec
 Nockenschraube
 Toe screw

N° de code	Prix	Frs
Bestell Nr	Preis	
Order Nr	Price	
VO2416.0000	5.50	

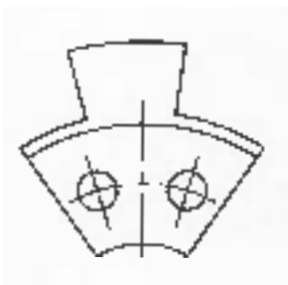

Bec d'embrayage
 Einschalt-Nocken
 Engaging toe

N° de code	Prix	Frs
Bestell Nr	Preis	
Order Nr	Price	
VO2373.0000		



Taquets du bec P133
 Nocken P133
 Toe P133

N° de code	Prix	Frs
Bestell Nr	Preis	
Order Nr	Price	
VO2401.0000	13.50	

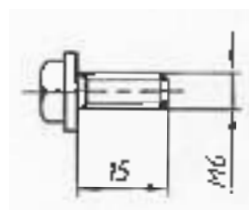

Vis du bec
 Nockenschraube
 Toe screw

N° de code	Prix	Frs
Bestell Nr	Preis	
Order Nr	Price	
VO2406.0000	5.50	



**TAQUETS ET VIS TORNOS
TORNOS NOCKEN UND SCHRAUBEN
TORNOS TOES AND SCREWS**

Taquets de numbrage P133
Schalt-Nocken P133
Indexing toes P133



N° de code Bestell Nr Order Nr	Appareil Apparat Attachment	M mm	Prix Frs Preis Price
VO2400.0000	M-4	M5	13.50
VO2401.0000	M-7 MS-7 R-10	M6	13.50
VO2402.0000	R-16	M7	13.50
VO2403.000	RR-20 MR-32 M-28	M8	13.50

Vis pour taquets de numbrage
Schraube für Schaltnocken
Screw for indexing-toe P

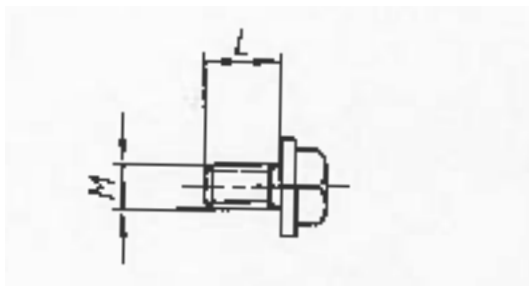

N° de code Bestell Nr Order Nr	Appareil Apparat Attachment	Ø M mm	L mm	Prix Frs Preis Price
VO2404.0000	M-4	M5	14	5.50
VO2405.0000	M-7 MS-7 R-10	M6	13	5.50
VO2406.0000	M-7 MS-7 R-10	M6	15	5.50
VO2407.0000	R-16	M7	17	5.50
VO2408.000	RR-20 MR-32 M-28	M8	20	5.50



**TAQUETS ET VIS TORNOS
TORNOS NOCKEN UND SCHRAUBEN
TORNOS TOES AND SCREWS**

Taquets de perçage rallongés P134
Verlängerte Bohr-Nocken P134
Extended drilling toes P134

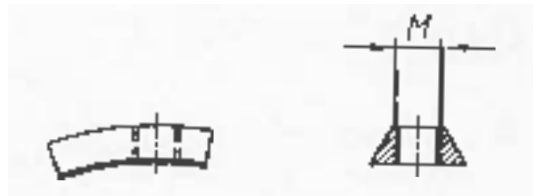

N° de code Bestell Nr Order Nr	Appareil Apparat Attachment	M mm	Prix Frs Preis Price
VO2430.0000	M-7 MS-7 R-10	M6	17.50

Vis pour taquets de perçage rallongés
Schraube für verlängerte Bohrnocken
Screw for extended drilling toe

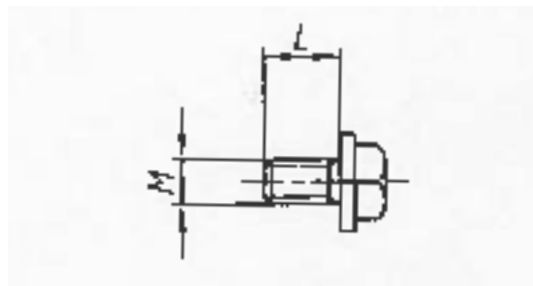

N° de code Bestell Nr Order Nr	Appareil Apparat Attachment	Ø M mm	L mm	Prix Frs Preis Price
VO2431.0000	M-7 MS-7 R-10	M6	10	6.50
VO2432.0000	M-7 MS-7 R-10	M6	11	7.00



**TAQUETS ET VIS TORNOS
TORNOS NOCKEN UND SCHRAUBEN
TORNOS TOES AND SCREWS**

Taquets de perçage rallongés P134
Verlängerte Bohr-Nocken P134
Extended drilling toes P134

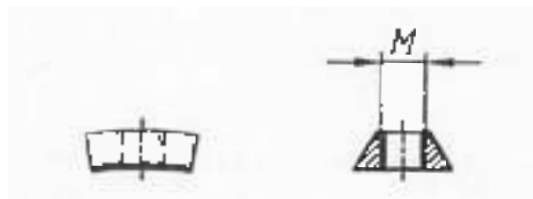

N° de code Bestell Nr Order Nr	Machines TORNOS TORNOS maschinen TORNOS machines	M mm	Prix Frs Preis Price
VO2410.0000	M-4	M5	15.50
VO2411.0000	M-7 MS-7 R-10	M6	15.50
VO2412.0000	R-16	M7	15.50
VO2413.0000	RR-20 MR-32 M-20 M-28	M8	15.50
VO2414.0000	Appareil 34-DA	M6	15.50

Vis pour taquets de perçage
Schraube für Bohr-Nocken
Screw for drilling toe

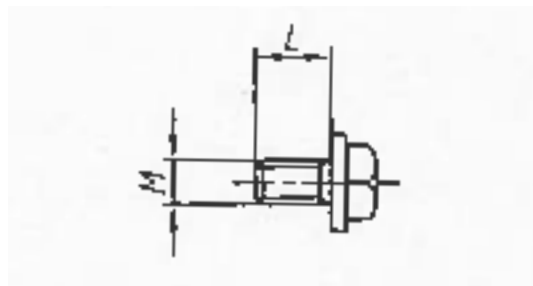

N° de code Bestell Nr Order Nr	Machines TORNOS TORNOS maschinen TORNOS machines	Ø M mm	L mm	Prix Frs Preis Price
VO2415.0000	M-4	M5	8	7.50
VO2416.0000	M-7 MS-7 R-10	M6	10	7.50
VO2417.0000	M-7 MS-7 R-10	M6	11	7.50
VO2418.0000	R-16	M7	12	7.50
VO2419.0000	RR-20 MR-32 M-20 M-28	M8	20	7.50
VO2420.0000	Appareil 34-DA			7.50



**PIÈCES POUR TOURS MULTIBROCHES TORNOS
ERSATZTEILE FUER MEHRSPINDEL-AUTOMATEN TORNOS
SPARE PARTS FOR MULTISPINDLE AUTOMATICS TORNOS**

**POUSSETTES CADDIE
STOSS-STANGEN CADDIE
PUSHRODS CADDIE**



N° de code Bestell Nr Order Nr	Ø D mm	L mm	M mm à gauche Links Left	Capacité Durchlass Capacity	Prix Frs Preis Price
VO5100.0000	8,50	939	M5	Ø 4,00 - 6,50	504.00
VO5101.0000	9,50	927	M6	Ø 6,50 - 8,50	530.00
VO5102.0000	10,50	927	M6	Ø 7,50 - 9,50	540.00
VO5103.0000	12,50	927	M6	Ø 9,50 - 10,50	570.00
VO5104.0000	15	914	M7	Ø 10,50 - 13,50	630.00
VO5105.0000	16,50	914	M8	Ø 13,50 - 16,00	660.00
VO5106.0000	17	914	M8	Ø 13,50 - 16,00	670.00

**DRAPEAU CADDIE
STOSS-STANGENFAHNE CADDIE
PUSHROD FLAG CADDIE**



N° de code Bestell Nr Order Nr	Prix Frs Preis Price
VO5107.0000	280.00

**RESSORTS DE COMPRESSION CADDIE
DRUCKFEDERN CADDIE
COMPRESSION SPRINGS CADDIE**

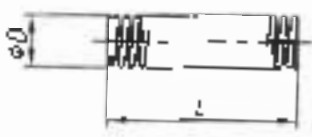

N° de code Bestell Nr Order Nr	Ø D mm	L mm	Prix Frs Preis Price
VO5108.0000	8,50	13	15.00
VO5109.0000	9,50	84	19.00



**PIÈCES POUR TOURS MULTIBROCHES TORNOS
TEILE FUER TORNOS MEHRSPINDLER
PARTS FOR MULTISPINDLE TORNOS MACHINES**

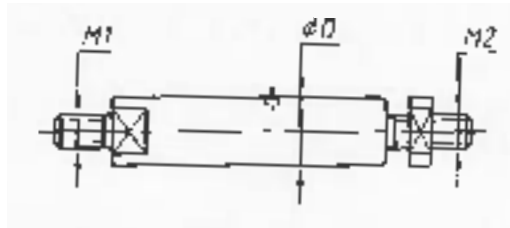

**EMBOUS TOURNANTS POUR RAVITAILLEURS CADDIE
DREHENDE ENDSTUECKE FUER CADDIE STANGENLADER
REVOLVING END-PIECES FOR CADDIE BAR-LOADER**

N° de code Bestell Nr Order Nr	Ø D mm	M1 mm	M2 mm à gauche Links Left	Prix Frs Preis Price
VO5110.0000	8,50	M5	M5	138.00
VO5111.0000	9,50	M6	M6	142.00
VO5112.0000	10,50	M6	M6	148.00
VO5113.0000	12,50	M6	M6	172.00
VO5114.0000	15	M7	M6	196.00
VO5115.0000	16,50	M8	M8	212.00
VO5116.0000	17	M8	M8	224.00

**PINCES POUR RAVITAILLEURS CADDIE
KLEMMZANGEN FUER CADDIE STANGENLADER
CLAMPING FINGERS FOR CADDIE BAR-LOADER**

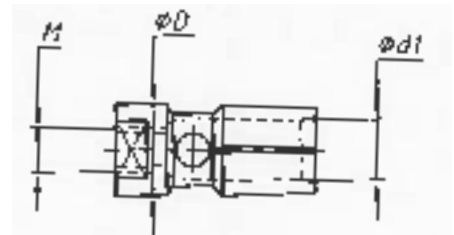

SERIE 5120

N° de code Bestell Nr Order Nr	Ø D mm	Alésage Ø d1 mm Bohrung Bore	M mm à gauche Links Left	Prix Frs Preis Price
VO5120.0000	8,50	1 - 7,5	M5	43.00
VO5121.0000	9,50	1 - 8,5	M6	44.00
VO5122.0000	10,50	2 - 9,5	M6	45.00
VO5123.0001	12	2 - 11	M6	45.00
VO5123.0000	12,50	2 - 11,5	M6	45.00
VO5124.0000	13,50	2 - 12,5	M6	46.00
VO5125.0000	15	2 - 14	M6	48.00
VO5126.0000	16	3 - 15	M8	49.00
VO5126.0001	16,50	3 - 15,5	M8	49.00
VO5127.0000	17,50	3 - 16,5w	M8	54.00



**PIÈCES POUR TOURS MULTIBROCHES TORNOS
ERSATZTEILE FUER MEHRSPINDEL-AUTOMATEN TORNOS
SPARE PARTS FOR MULTISPINDLE AUTOMATICS TORNOS**

**MACHOIRES POUR PINCES MAITRESSE
BACKEN FUER MUTTERZANGE
JAWS FOR MASTER-COLLET**

1 = Bronze - Bronze - bronze
2 = Acier - Stahl - Steel

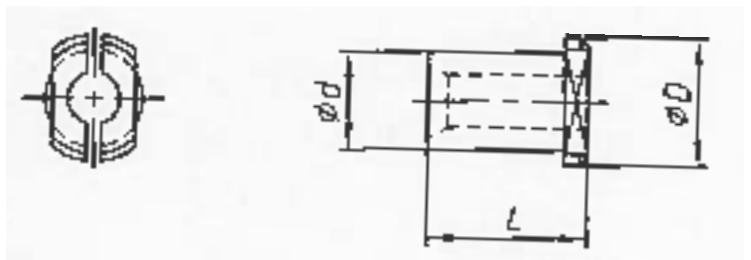

N° de code Bestell Nr Order Nr	Machines TORNOS TORNOS Maschinen TORNOS machines	ϕd mm	ϕD mm	L mm	Matière Material Materiel	Prix Frs Preis Price
VO5151.0000	AS-14	13,5	16	21	1	54.00
VO5151.0001	AS-14	13,5	16	21	2	50.00
VO5151.0002	SAS-16	16,5	20	21	1	61.00
VO5151.0003	SAS-16	16,5	20	21	2	57.00
VO5151.0004	BS-20	21,5	24	26	1	68.00
VO5151.0005	BS-20	21,5	24	26	2	64.00

**CLÉ POUR PINCE MAITRESSE A 17,9
SCHLUESSEL FUER MUTTERZANGE A 17,9
WRENCH FOR MASTER-COLLET A 17,9**

N° de code Bestell Nr Order Nr	Prix Frs Preis Price
VO5152.0000	55.00

VO5152.0000 55.00

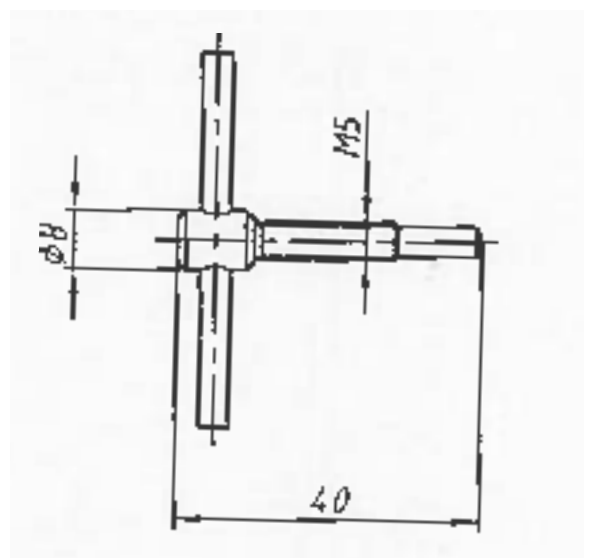



**PIÈCES POUR TOURS MULTIBROCHES TORNOS
ERSATZTEILE FUER MEHRSPINDEL-AUTOMATEN TORNOS
SPARE PARTS FOR MULTISPINDLE AUTOMATICS TORNOS**

**BARILLET AS-14 CHIENS DE SERRAGE ET AXES
SPINDEL TROMMEL AS-14 SPANNKNAGEN UND ACHSEN
BARREL AS-14 TOGGLE AND AXLE**

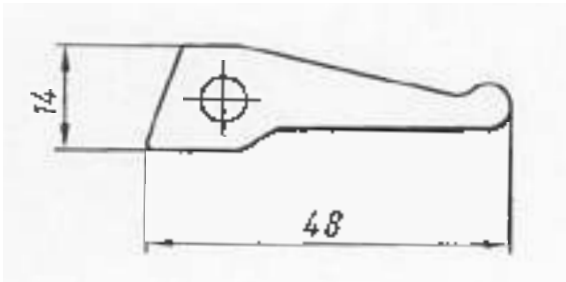

N° de code	Prix Frs
Bestell Nr	Preis
Order Nr	Price
VO5160.0000	165.00

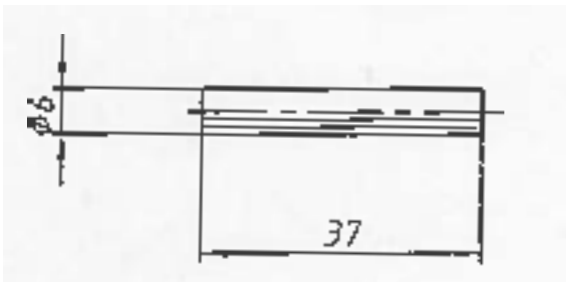

N° de code	Prix Frs
Bestell Nr	Preis
Order Nr	Price
VO5161.0000	7.50

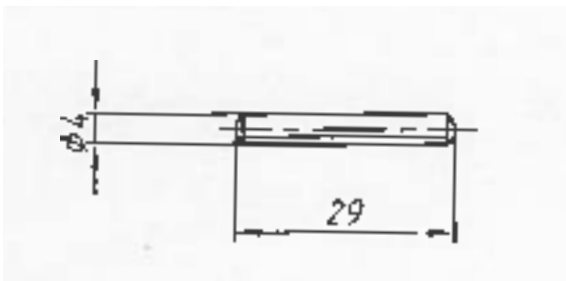

N° de code	Prix Frs
Bestell Nr	Preis
Order Nr	Price
VO5162.0000	7.80

**GOUPILLE DE SÉCURITÉ AS-14
SICHERHEITSSTIFT AS-14
SECURITY PIN AS-14**

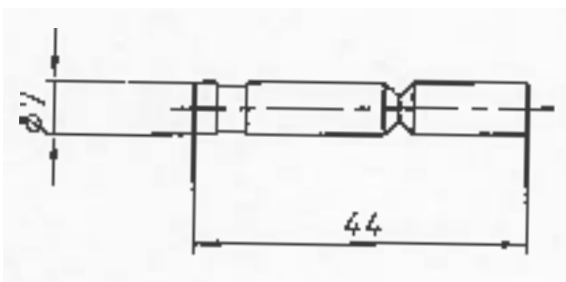

N° de code	Prix Frs
Bestell Nr	Preis
Order Nr	Price
VO5163.0000	7.50



**PIÈCES POUR TOURS MULTIBROCHES TORNOS
ERSATZTEILE FUER MEHRSPINDEL-AUTOMATEN TORNOS
SPARE PARTS FOR MULTISPINDLE AUTOMATICS TORNOS**

**TAQUET ET VIS AS-14
NOCKEN UND SCHRAUBE AS-14
TOE AND SCREW AS-14**

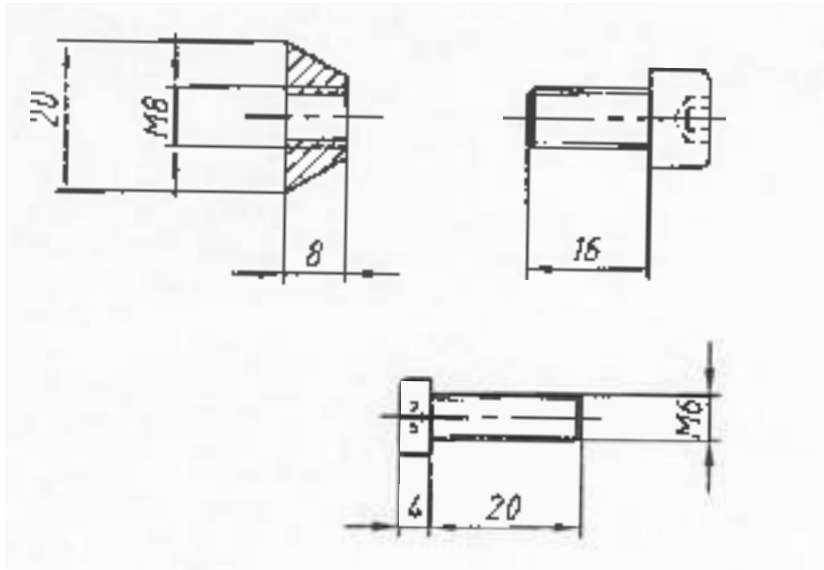

N° de code	Prix Frs
Bestell Nr	Preis
Order Nr	Price
VO5170.0000	15.50

N° de code	Prix Frs
Bestell Nr	Preis
Order Nr	Price
VO5171.0000	8.00

**VIS POUR CADDIE
SCHRAUBE FUER CADDIE
SCREW FOR CADDIE**

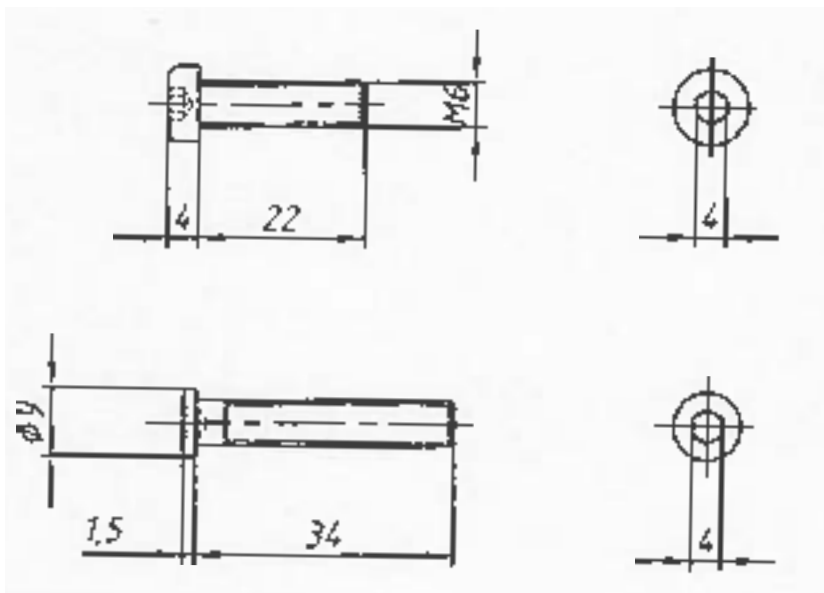

N° de code	Prix Frs
Bestell Nr	Preis
Order Nr	Price
VO5172.0000	8.00

N° de code	Prix Frs
Bestell Nr	Preis
Order Nr	Price
VO5173.0000	8.00



PINCES POUR RAVITAILLEURS ZANGEN FUER STANGENLADER COLLETS FOR BARLOADER

Pince courte
Kurze Zange
Short collet

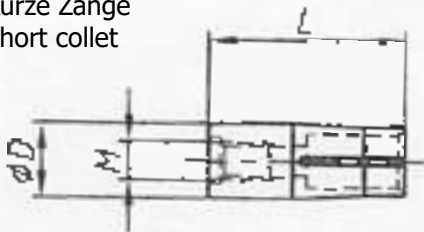

Pince longue
Lange Zange
Long collet

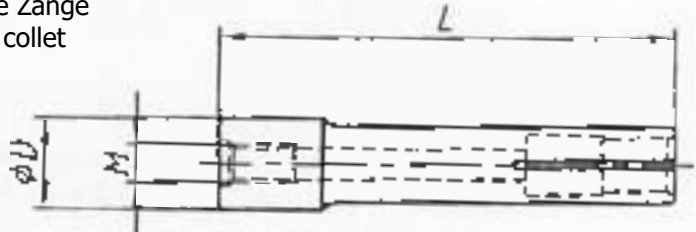

MULTIBAR BECHLER

N° de code Bestell Nr Order Nr	Type Typ Type	Ø D mm	L mm	M mm	Prix Frs Preis Price
VO6100.0000	320	4,5	22	M2,5	21.40
VO6101.0000	3000-H	5	22	M3	21.50
VO6102.0000	65-5,5	5,5	22	M3,5	22.50
VO6103.0000	65 / 73	7	22	M4	21.90
VO6104.0000	65 / 73	10	26	M5	23.50
VO6105.0000	65 / 73	12	26	M5	32.50
VO6106.0000	12 longue	12	60	M5	35.00
VO6108.0000	16 courte	16	30	M6	44.00
VO6109.0000	16 longue	16	60	M6	46.00
VO6110.0000	20 courte	20	30	M8x1	48.00
VO6111.0000	20 longue	20	60	M8x1	48.00

EMBOUS TOURNANTS SIMPLES POUR POUSSE-BARRES EINFACHE DREHENDE ENDSTUECKE FUER STOSS-STANGEN SIMPLE REVOLVING END-PIECES FOR PUSHRODS

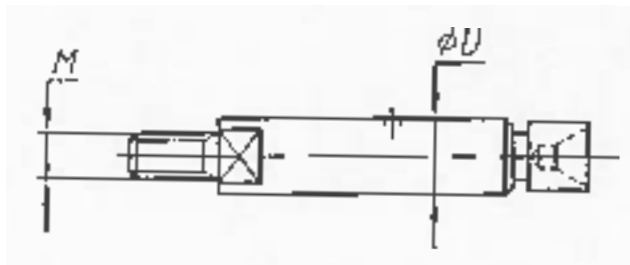

N° de code Bestell Nr Order Nr	Ø D mm	M mm	Prix Frs Preis Price
VO1150.0000	4,50	M 3,5	48.00
VO1151.0000	7	M 5	65.00
VO1152.0000	10	M 6	80.00
VO1153.0000	12	M 6	110.00
VO1154.0000	14	M 8	120.00
VO1155.0000	16	M 10	140.00
VO1156.0000	20	M 10	162.00
VO1157.0000	25	M 12	180.00

Autres dimensions sur demande
Weitere Masse auf verlangen
Other sizes on request



**PIÈCES POUR TRANSPORTEUR BECHLER
ZANGEN FUER TRANSPORTER BECHLER
COLLETS FOR TRANSPORTING ARM BECHLER**

Ebauche type AR-10 625
Rohling Typ AR-10 625
Blank type AR-10 625

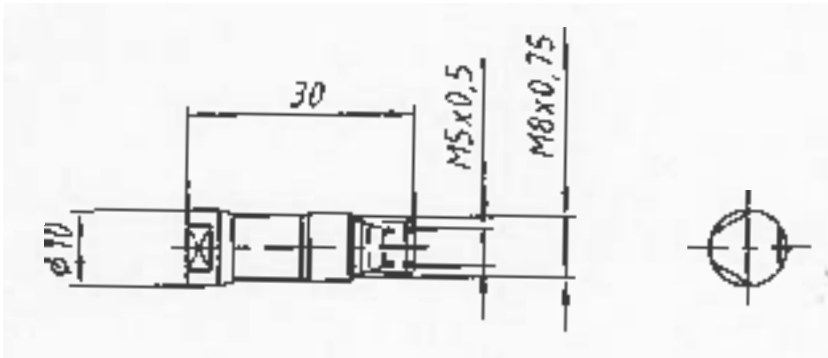

N° de code Bestell Nr Order Nr	Prix Frs Preis Price
VO6126.0000	28.00

Finition
Fertiger Teil
Finished part

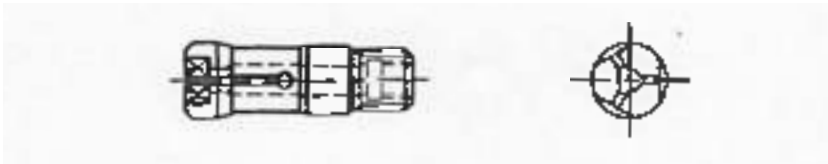

N° de code Bestell Nr Order Nr	Prix Frs Preis Price
VO6127.0000	210.00

**BECS DE SÉCURITÉ POUR TRANSPORTEUR BECHLER
SICHERHEITS-NOCKEN FUER BECHLER TRANSPORTER
SAFETY TOES FOR BECHLER TRANSPORTING ARM**

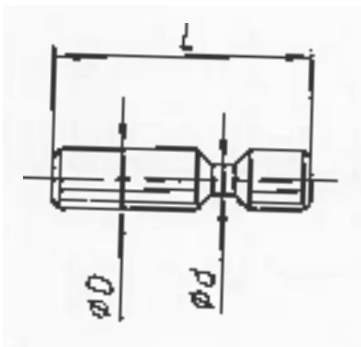

N° de code Bestell Nr Order Nr	Ø D mm	M mm	Ø d mm	Prix Frs Preis Price
VO6128.0000	8	34	4	7.50
VO6129.0000	8	34	4,5	7.50
VO6130.0000	10	35	4	7.50



**EMBOUS TOURNANTS POUR MULTIBAR BECHLER
DREHENDES ENDSTUECKE FUER MULTIBAR BECHLER
REVOLVING END-PIECES FOR MULTIBAR BECHLER**

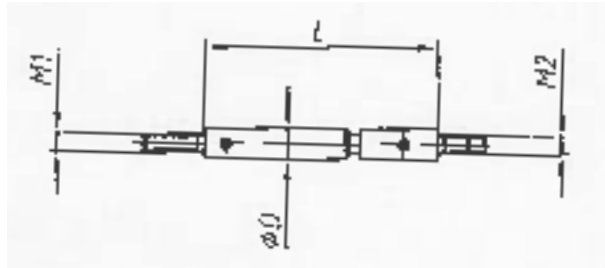

N° de code Bestell Nr Order Nr	Ø D mm	L mm	M1 mm	M2 mm	Multibar	Prix Frs Preis Price
VO6140.0000	4,5	37,5	M3	M2,5	320 / 65	62.00
VO6141.0000	5	58,5	M3,5	M3	3000-H / 73	74.00
VO6142.0000	5,5	37,5	M4	M3,5	5,5 / 65	74.00

**EMBOUS TOURNANTS POUR MULTIBAR BECHLER
DREHENDES ENDSTUECKE FUER MULTIBAR BECHLER
REVOLVING END-PIECES FOR MULTIBAR BECHLER**

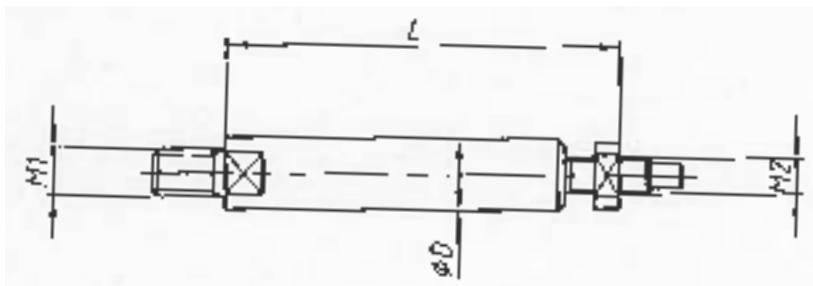

N° de code Bestell Nr Order Nr	Ø D mm	L mm	M1 mm	M2 mm	Multibar	Prix Frs Preis Price
VO6143.0000	7	38,5	M5	M4	7 Type 65 court	90.00
VO6144.0000	7	61	M5	M4	3000/7 Type 73 long	90.00
VO6145.0000	10	59	M6	M5	10 Type 65 court	115.00
VO6146.0000	10	75	M6	M5	3000/10 Type 73 long	115.00
VO6147.0000	12	64	M8 / M6	M5	12 Type 65 court BR - 3000/12 Type 73 BR	136.00
VO6148.0000	12	94	M8 / M6	M5	12 Type 65 court BR - 3000/12 Type 73 AR	146.00
VO6151.0000	13	64	M8 / M6	M6	3000/13 Type 73 BR	156.00
VO6152.0000	13	94	M8 / M6	M6	3000/13 Type 73 AR	166.00
VO6153.0000	16	84	M12	M6	16	205.00
VO6154.0000	20	84	M16	M8x1	20	232.00



**POUSSETTES MULTIBAR A CORDE TYPE 65 POUR TOURS AUTOMATIQUES BECHLER
MULTIBAR STOSS-STANGEN MIT SAITE TYP 65 FUER BECHLER AUTOMATEN
MULTIBAR PUSHRODS WITH CORD TYPE 65 FOR BECHLER AUTOMATICS**

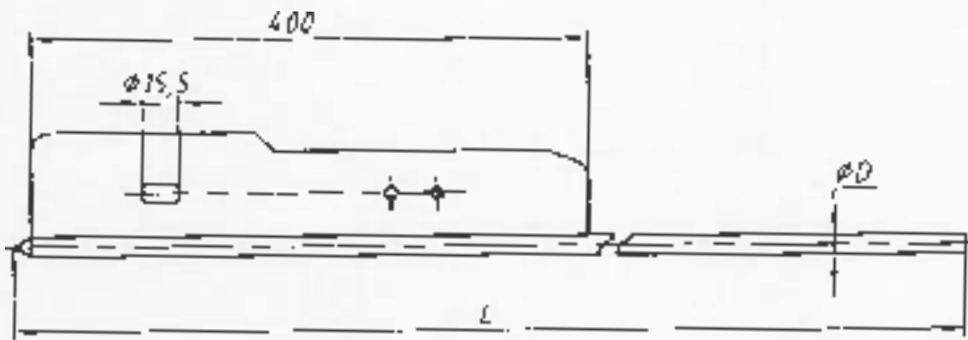

N° de code Bestell Nr Order Nr	Ø D mm	L mm	Prix Frs Preis Price
VO6180.0000	4,50	1033	176.00
VO6181.0000	5,50	1033	196.00
VO6182.0000	7	980	198.00
VO6183.0000	7	1028	198.00
VO6184.0000	10	948	209.00
VO6185.0000	10	1008	211.00

**POUSSETTES MULTIBAR A CORDE TYPE 65 POUR TOURS AUTOMATIQUES BECHLER/PETERMANN
MULTIBAR STOSS-STANGEN MIT SAITE TYP 65 FUER BECHLER/PETERMANN AUTOMATEN
MULTIBAR PUSHRODS WITH CORD TYPE 65 FOR BECHLER/PETERMANN AUTOMATICS**

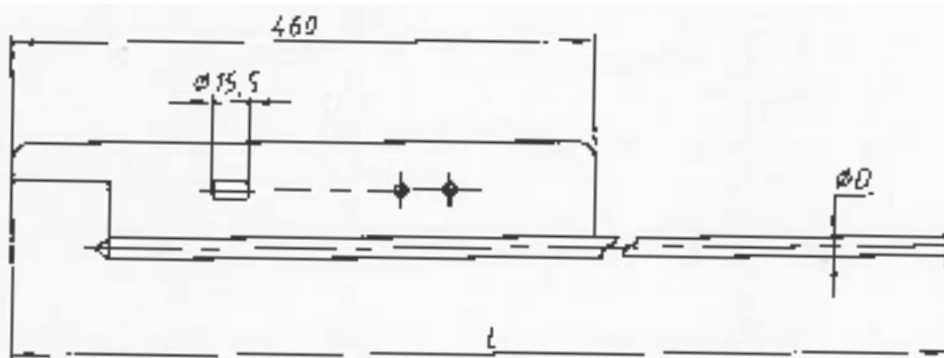

N° de code Bestell Nr Order Nr	Ø D mm	L mm	Prix Frs Preis Price
VO6186.0000	7	1303	246.00
VO6187.0000	10	1278	260.00



POUSSETTES MULTIBAR A CHAINE TYPE 65 POUR TOURS AUTOMATIQUES BECHLER
MULTIBAR STOSS-STANGEN MIT KETTE TYP 65 FUER BECHLER AUTOMATEN
MULTIBAR PUSHRODS WITH CHAIN TYPE 65 FOR BECHLER AUTOMATICS

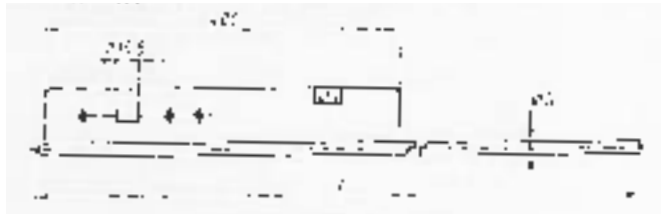

N° de code Bestell Nr Order Nr	Ø D mm	L mm	Prix Frs Preis Price
VO6188.0000	4,50	1033	176.00
VO6189.0000	5,50	1033	196.00
VO6190.0000	7	1018	240.00
VO6191.0000	7	1028	240.00
VO6192.0000	7	1305	248.00
VO6193.0000	10	1018	262.00
VO6194.0000	16	1266	300.00
VO6195.0000	20	1273	350.00

POUSSETTES MULTIBAR POUR TOURS AUTOMATIQUES BECHLER AR ET BR
MULTIBAR STOSS-STANGEN FUER BECHLER AUTOMATEN AR UND BR
MULTIBAR PUSHRODS FOR BECHLER AUTOMATICS AR AND BR

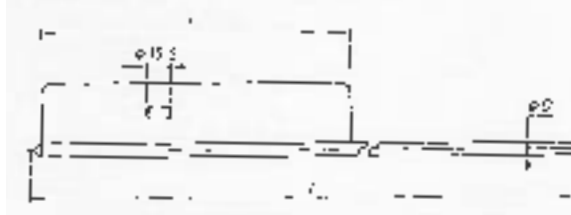

N° de code Bestell Nr Order Nr	Machines BECHLER BECHLER Maschinen BECHLER machines	Ø D mm	l mm	L mm	Prix Frs Preis Price
VO6200.0000	AR	5	160	733	108.00
VO6201.0000	BR	5	200	917	188.00
VO6202.0000	AR	7	160	753	188.00
VO6203.0000	AR	7	160	965	188.00
VO6203.0001	BR	7	220	965	132.00
VO6204.0000	AR	7	160	980	118.00
VO6205.0000	AR	10	160	712	128.00
VO6206.0000	BR	10	220	948	142.00
VO6207.0000	BR	12	220	980	162.00
VO6208.0000	AR	12	160	712	148.00
VO6209.0000	BR	20	220	925	320.00



CHAINES ET RACCORDS POUR BECHLER
KETTEN UND VERBINDUNGEN FUER BECHLER
CHAINS AND CONNECTION LINKS FOR BECHLER

1 = Chaîne - Kette - Chain
 2 = Raccord - Verbindung - Connector

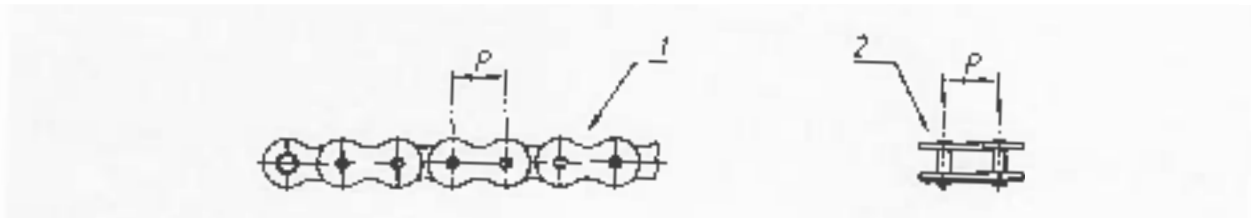

N° de code Bestell Nr Order Nr	Type	Chaîne Kette Chain	P mm	Prix Frs Preis Price
VO6210.0000	Multibar 65	6	1	
VO6211.0000	Multibar 73 / 3000 H	8	1	
VO6212.0000	Multibar 65	6	2	
VO6213.0000	Multibar 73 / 3000 H	8	2	

POUSSETTES SIMPLES POUR TOURS AUTOMATIQUES BECHLER
EINFACHE STOSS-STANGEN FUER LANGDREHAUTOMATEN BECHLER
SIMPLE PUSHRODS FOR AUTOMATICS BECHLER

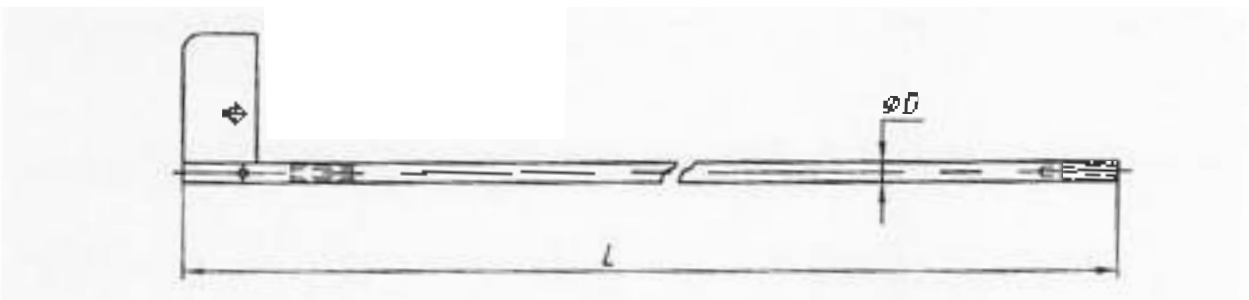

N° de code Bestell Nr Order Nr	Machines BECHLER BECHLER Maschinen BECHLER machines	Ø D mm	L mm	Prix Frs Preis Price
VO6215.0000	AS-4	4,50	800	60.00
VO6216.0000	AS-7	6,50	800	62.00
VO6217.0000	AR-10	10	800	65.00
VO6218.0000	BE-12	12	1060	85.00



**GOUPILLES DE SÉCURITÉ BECHLER
SICHERUNGSSTIFTE BECHLER
LOCKING PINS BECHLER**

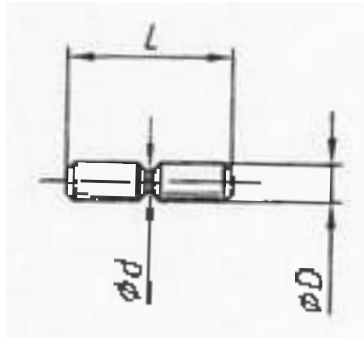

N° de code Bestell Nr Order Nr	Machines Maschinen Machines	Ø D mm	L mm	Ø d mm	Prix Frs Preis Price
VO6220.0000	AS / AR	4	19	2,10	7.50
VO6220.0001	AS / AR	4	19	2,40	7.50
VO6221.0000	B / BR	5	23	3,50	7.50

**DRAPEAU INTERCHANGEABLE BECHLER B ET BR-20
AUSWECHSELBARE FAHNE BECHLER B UND BR-20
CHANGEABLE FLAG BECHLER B AND BR-20**

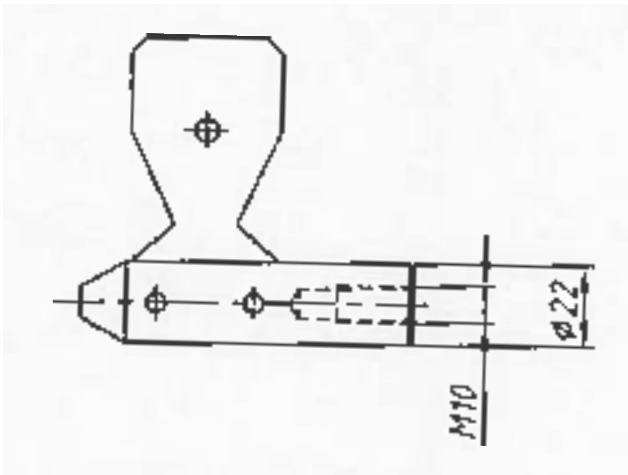

N° de code Bestell Nr Order Nr	Prix Frs Preis Price
VO6223.0000	160.00



**POUSSETTES POUR RAVITAILLEURS BECHET
STOSS-STANGEN FUER BECHET STANGENLADER
PUSHRODS FOR BECHET BARLOADER**

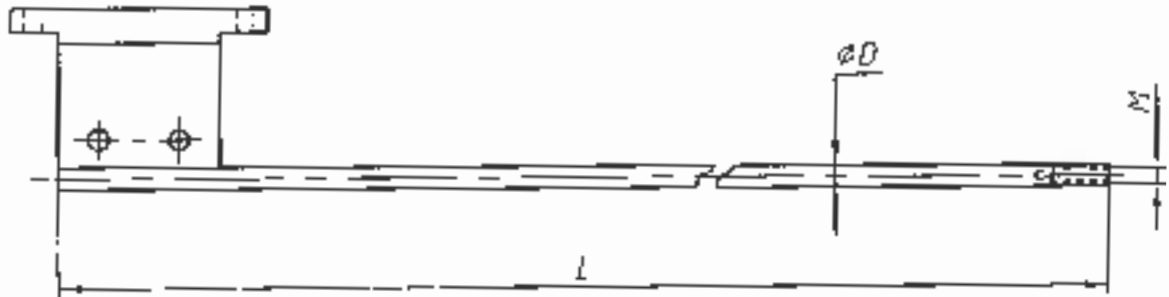

N° de code Bestell Nr Order Nr	Ø D mm	L mm	M mm	Embouts Endstück End-piece	Prix Frs Preis Price
VO8120.0000	5	923	M3,5	Bechler 3000-H	55.00
VO8122.0000	7	881	M5	Bechler ou FMB 7	73.00
VO8123.0000	7	916	M5	Bechler 7 long	73.00
VO8124.0000	10	838,5	M7	Bechler ou FMB 10	80.00
VO8125.0000	10	892,5	M6	Bechler 10 long	80.00
VO8126.0000	12	838	M8	Bechler ou FMB 12	84.00
VO8127.0000	12	910	M8	Bechler 12	84.00
VO8128.0000	15	839	M10	Bechler ou FMB 15	90.00
VO8129.0000	15	895	M7	Tornobar	90.00
VO8130.0000	20	787	M14	Béchet ou FMB 20	100.00
VO8131.0000	20	885	M16	Bechler 20	100.00

**DRAPEAUX POUR POUSSETTE BECHET
FAHNEN FUER BECHET STOSS-STANGE
FLAGS FOR BECHET PUSHROD**

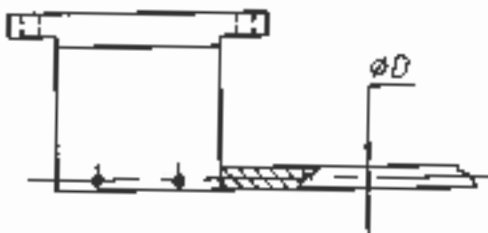

N° de code Bestell Nr Order Nr	Ø D mm	Prix Frs Preis Price
VO8132.0000	7	28.00
VO8133.0000	10	30.00
VO8134.0000	12	32.00
VO8135.0000	15	38.00
VO8136.0000	20	42.00



**EMBOUTS TOURNANTS POUR CHARGEURS BECHET
DREHENDE ENDSTUECKE FUER BECHET STANGENLADER
REVOLVING END-PIECES FOR BECHET BARLOADER**

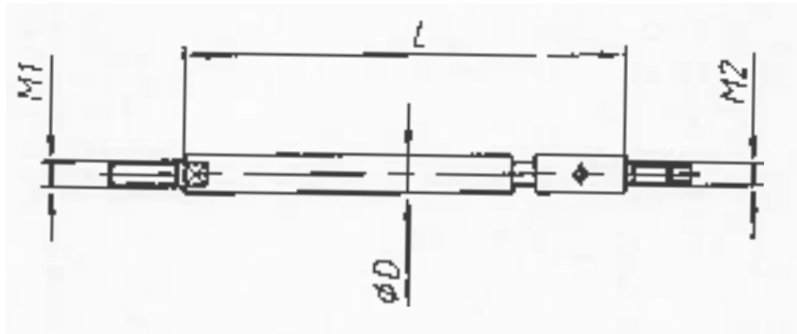

N° de code Bestell Nr Order Nr	Type de chargeur Typ von Stangenlager Type for barloader	Ø D mm	L mm	M1 mm	M2 mm	Prix Frs Preis Price
VO8140.0000	Canal Ø 5	5	58,5	M3,5	M3	74.00
VO8141.0000	Canal Ø 7	7	78,5	M5	M5	130.00

**EMBOUTS TOURNANTS POUR CHARGEURS BECHET
DREHENDE ENDSTUECKE FUER BECHET STANGENLADER
REVOLVING END-PIECES FOR BECHET BARLOADER**

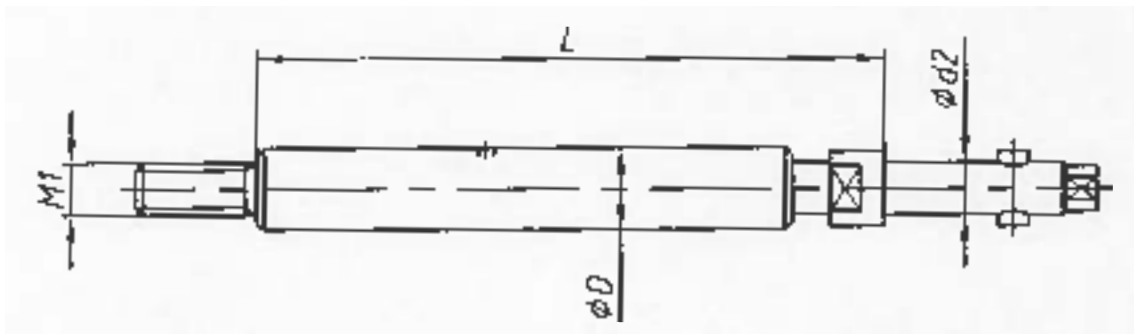

N° de code Bestell Nr Order Nr	Type de chargeur Typ von Stangenlager Type for barloader	Ø D mm	L mm	M1 mm	M2 mm	Prix Frs Preis Price
VO8142.0000	Canal Ø 10	10	116	M7	7	143.00
VO8143.0000	Canal Ø 12	12	116	M8	8	160.00
VO8144.0000	Canal Ø 15	15	116	M10	11	183.00
VO8145.0000	Canal Ø 20	20	148	M14	14	224.00
VO8146.0000	Canal Ø 32	30	124	M24	M18	250.00



**PINCES POUR RAVITAILLEURS
ZANGEN FUER STANGENLADER
COLLETS FOR BARLOADER**

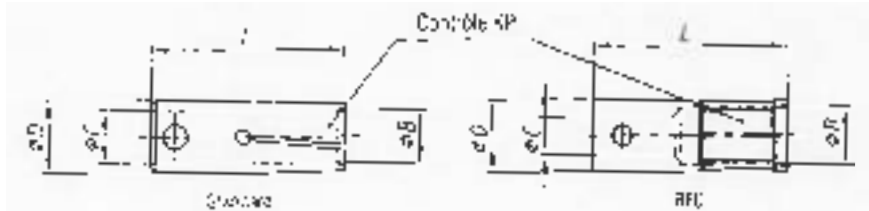

FMB - TRAUB - HAGENUK - IEMCA - ROBOBAR - LNS - SAMECA - MINISPRINT - MINITURBO

N° de code Bestell Nr Order Nr	Ø D mm	Standard	RFC	Ecart Abstand Distance	Ø C mm	L mm	Prix Preis Price
		Alésage Bohrung Bore	Alésage Bohrung Bore				
VO9100.0000 - 0001	7	2 - 5,5	5,6 - 6	0,10 - 0,10	M5	37	25.00
VO9101.0000 - 0001	10	3 - 8	8,1 - 8,5	0,10 - 0,10	7	40	29.50
VO9102.0000 - 0001	12	4 - 10	10,1 - 10,5	0,10 - 0,10	8	40	30.00
VO9103.0000 - 0001	15	7 - 13	13,1 - 13,5	0,10 - 0,10	11	40	34.00
VO9104.0000 - 0001	16	8 - 14	14,1 - 14,5	0,10 - 0,10	11	40	34.50
VO9105.0000 - 0001	18	8 - 15,5	16,6 - 16	0,10 - 0,10	11	40	37.50
VO9106.0000 - 0001	20	10 - 17,5	17,6 - 18	0,10 - 0,10	14	65	39.50
VO9107.0000 - 0001	25	15 - 22,5	22,6 - 23	0,10 - 0,10	20	65	42.00
VO9108.0000 - 0001	30	20 - 27,5	27,6 - 28	0,10 - 0,10	20	65	65.00
VO9109.0000 - 0001	32	20 - 29	29,1 - 30	0,10 - 0,10	20	65	70.00
VO9110.0000 - 0001	34	20 - 31	31,1 - 32	0,10 - 0,10	20	90	75.00
VO9111.0000 - 0001	36	20 - 33	33,1 - 34	0,10 - 0,10	20	90	80.00
VO9112.0000 - 0001	38	20 - 35	35,1 - 36	0,10 - 0,10	20	90	85.00
VO9113.0000 - 0001	40	20 - 37	37,1 - 38	0,10 - 0,10	20	90	90.00
VO9114.0000 - 0001	42	20 - 39	39,1 - 40	0,10 - 0,10	20	90	98.00

Dimensions spéciales - Spezial Ausmass - Special sizes

VO9115.0000 - 0001	5	1,5 - 4		0,10 - 0,10	M4	37	24.50
VO9117.0000 - 0001	13	4 - 11	11,1 - 11,5	0,10 - 0,10	8	40	62.00
VO9118.0000 - 0001	14	5 - 12	12,1 - 12,5	0,10 - 0,10	8	40	63.00
VO9119.0000 - 0001	17	8 - 15	15,1 - 15,5	0,10 - 0,10	11	40	74.00
VO9120.0000 - 0001	19	8 - 16,5	16,6 - 17	0,10 - 0,10	11	40	77.00
VO9121.0000 - 0001	21	12 - 18,5	18,6 - 19	0,10 - 0,10	11	65	81.00
VO9122.0000 - 0001	22	15 - 19,5	19,6 - 20	0,10 - 0,10	14	65	82.00
VO9123.0000 - 0001	23	15 - 20,5	20,6 - 21	0,10 - 0,10	14	65	83.00
VO9124.0000 - 0001	24	15 - 21,5	21,6 - 22	0,10 - 0,10	14	65	84.00
VO9125.0000 - 0001	26	20 - 23,5	23,6 - 24	0,10 - 0,10	20	65	85.00
VO9126.0000 - 0001	27	20 - 24,5	24,6 - 25	0,10 - 0,10	20	65	87.00
VO9127.0000 - 0001	28	20 - 25,5	25,6 - 26	0,10 - 0,10	20	65	89.00



**PINCES POUR RAVITAILLEURS
ZANGEN FUER STANGENLADER
COLLETS FOR BARLOADER**

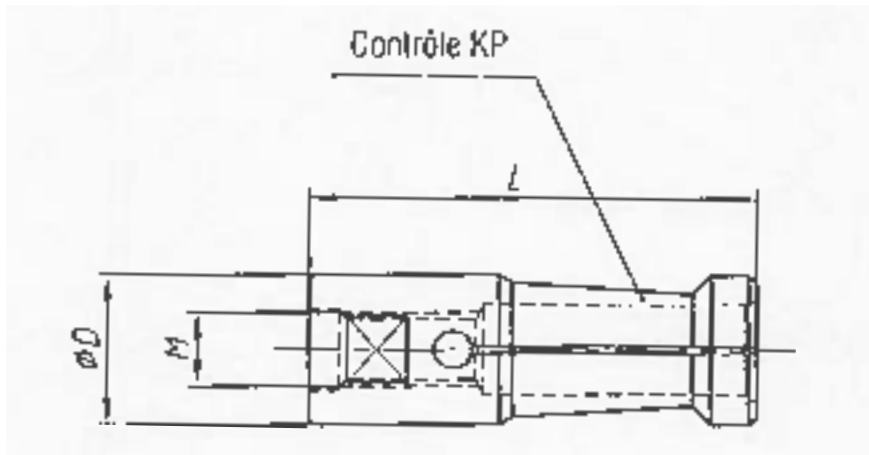

IEMCA AS / CS

N° de code Bestell Nr Order Nr	Ø D mm	L mm	M mm	Prix Frs Preis Price
VO9151.0000	5,5	37	M4 x 0,5	41.00
VO9152.0000	7	40	M5 x 0,5	41.00
VO9153.0000	7,5	40	M5 x 0,5	41.50
VO9155.0000	10	40	M6 x 0,75	43.00
VO9156.0000	12	42	M7 x 0,75	44.00
VO9157.0000	15	42	M8 x 1	45.00
VO9158.0000	16	42	M8 x 1	46.00
VO9159.0000	18	42	M8 x 1	48.00
VO9160.0000	20	59	M10 x 1	49.50
VO9162.0000	25	59	M10 x 1	57.00
VO9163.0000	27	59	M10 x 1	62.00



RG: 05

**PINCES POUR RAVITAILLEURS
ZANGEN FUER STANGENLADER
COLLETS FOR BARLOADER**

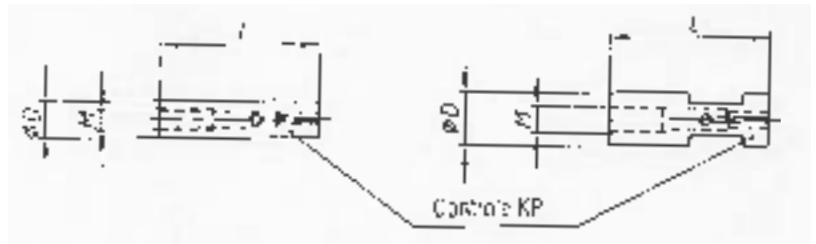

LNS TRYTON

N° de code Bestell Nr Order Nr	Ø D mm	L mm	M mm	Prix Frs Preis Price
VO9190.0000	6	30	M4	29.80
VO9191.0000	7	30	M4	33.50
VO9192.0000	10	30	M5	38.50
VO9193.0000	12	30	M6	44.50
VO9193.0001	12,5	30	M6	44.50
VO9194.0000	16,5	35	M8	45.50
VO9195.0000	17	35	M10	45.50
VO9196.0000	20	35	M10	46.80
VO9197.0000	22	35	M10	47.50
VO9198.0000	25	35	M10	49.00
VO9199.0000	30	35	M10	51.50
VO9200.000	32	35	M10	60.00

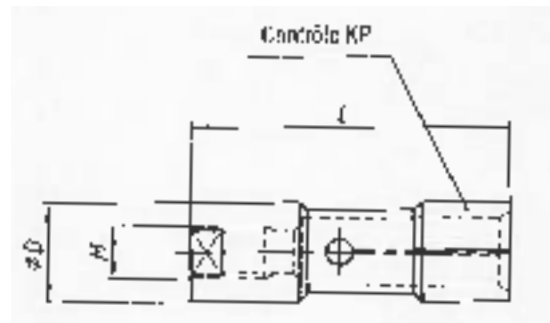

CUCCHI

N° de code Bestell Nr Order Nr	Type Typ Type	Ø D mm	L mm	M mm	Prix Frs Preis Price
VO9210.0000	Cucchi PB-10	10	52	M6 x 0,75	42.00
VO9211.0000	Cucchi PB-12	12	52	M7 x 0,75	44.00
VO9212.0000	Cucchi PB-15	14	52	M8 x 1	46.00
VO9213.0000	Cucchi PB-16	16	52	M8 x 1	48.00
VO9214.0001	Cucchi PB-20	19	60	M10 x 1	49.50
VO9217.0000	Cucchi PB-26	25	60	M14 x 1	57.00
VO9218.0000	Cucchi PB-30	30	65	M18 x 1,5	65.00
VO9219.0000	Cucchi PB-42	40	70	M25 x 1,5	90.00



**EMBOUITS TOURNANTS
DREHENDE ENDSTUECKE
REVOLVING END-PIECES**

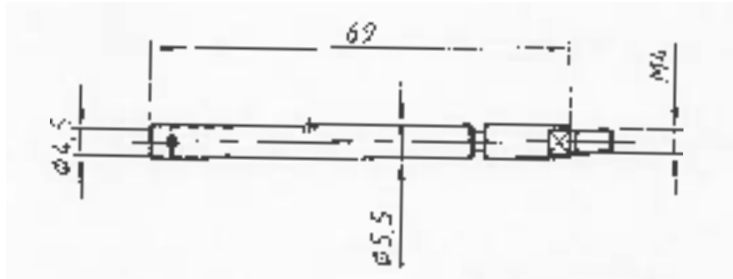

TRAUB-FMB-HAGENUK-LNS

N° de code	Prix Frs
Bestell Nr	Preis
Order Nr	Price
VO9220.0000	68.00

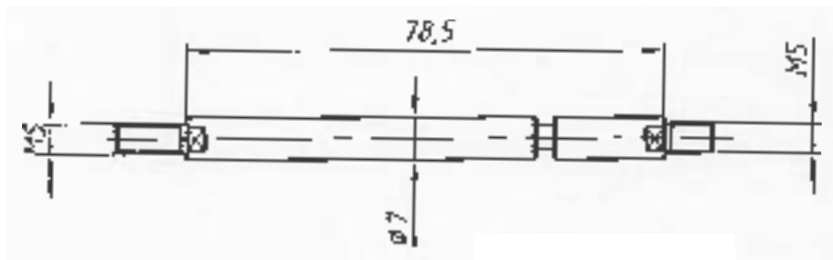

TRAUB-FMB-HAGENUK-LNS

N° de code	Prix Frs
Bestell Nr	Preis
Order Nr	Price
VO9221.0000	90.00

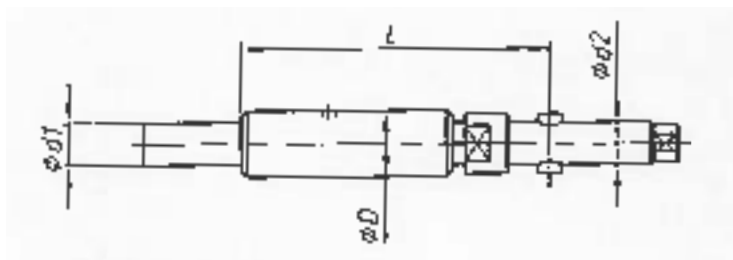

TRAUB-FMB-HAGENUK-LNS

N° de code	Ø D mm	L mm	Ød1 mm	Ød2 mm	Prix Frs
Bestell Nr					Preis
Order Nr					Price
VO9222.0000	10	51	8	7	137.50
VO9223.0000	12	51	8	8	139.00
VO9224.0000	15	51	12	11	149.00
VO9225.0000	18	51	12	11	162.00
VO9226.0001	20	56	17	14	170.00
VO9227.0000	25	58,5	20	20	175.00



**EMBOUS TOURNANTS
DREHENDE ENDSTUECKE
REVOLVING END-PIECES**

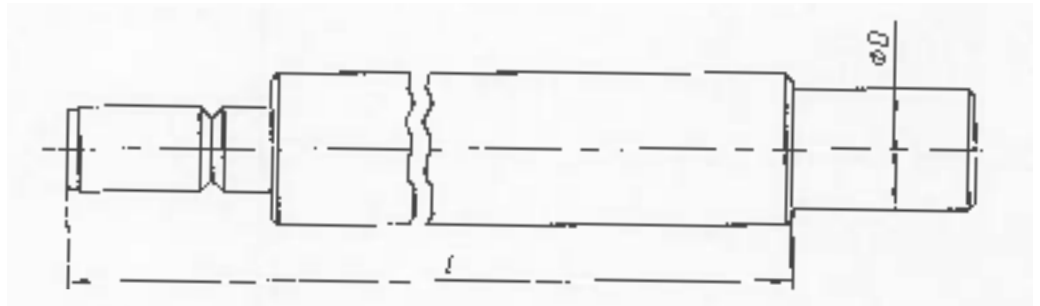

TRAUB-FMB

N° de code Bestell Nr Order Nr	Canal Kanal Canal	L mm	Ø D mm	Prix Frs Preis Price
VO9230.0000	25-D	197	20	234.00
VO9231.0000	28-D	197	20	240.00
VO9232.0000	30-D	197	22	250.00
VO9233.0000	32-D	197	24	260.00
VO9234.0000	36-D	207	30	265.00

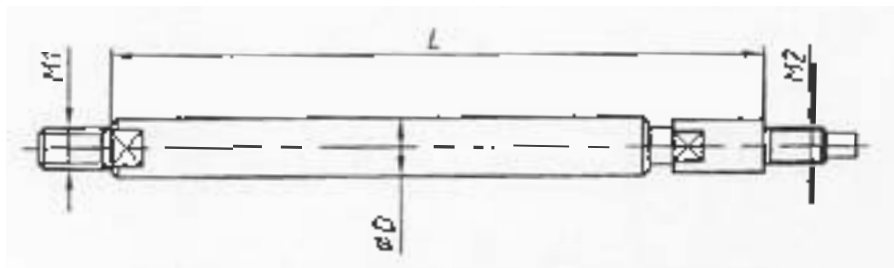

CUCCHI

N° de code Bestell Nr Order Nr	Ø D mm	L mm	M1 mm	M2 mm	Prix Frs Preis Price
VO9250.0000	10	108	M7	M6 x 0,75	137.00
VO9251.0000	12	108	M8	M7 x 0,75	158.00
VO9252.0000	14	103	M10	M8 x 1	188.00
VO9253.0000	16	108		M8 x 1	188.00
VO9254.0000	19	108	M12	M10 x 1	204.00
VO9254.0001	24				220.00
VO9255.0000	25	117	M20 x 1,5	M14 x 1	220.00
VO9256.0000	30	123,5	M24 x 1,5	M18 x 1,5	230.00



**EMBOUTS TOURNANTS
DREHENDE ENDSTUECKE
REVOLVING END-PIECES**

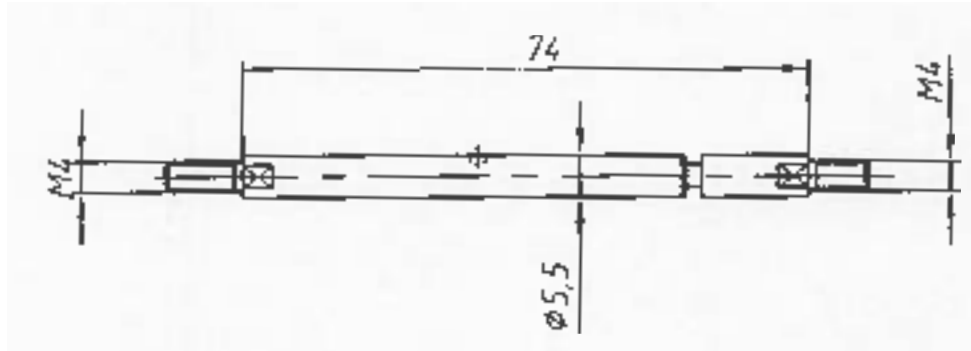

IEMCA pour pince FMB
IEMCA für Zange FMB
IEMCA for collet FMB

N° de code	Canal	Prix Frs
Bestell Nr	Kanal	Preis
Order Nr	Canal	Price
VO9260.0000	5-D	74.00

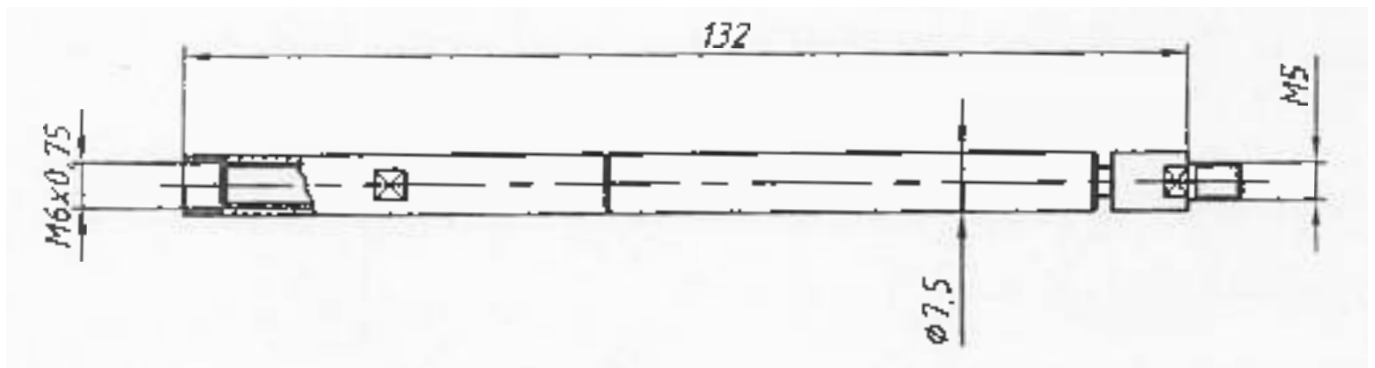

IEMCA pour pince FMB
IEMCA für Zange FMB
IEMCA for collet FMB

N° de code	Canal	Prix Frs
Bestell Nr	Kanal	Preis
Order Nr	Canal	Price
VO9261.0000	7-D	100.00



**EMBOUITS TOURNANTS
DREHENDE ENDSTUECKE
REVOLVING END-PIECES**

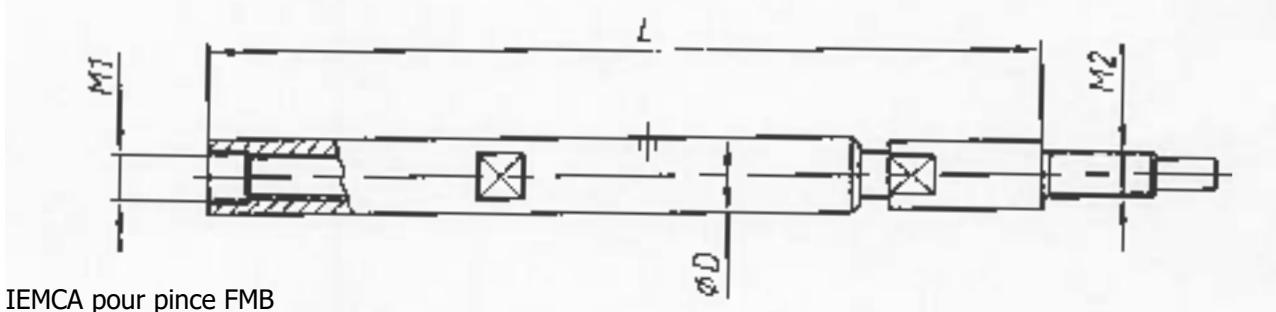

IEMCA pour pince FMB
IEMCA für Zange FMB
IEMCA for collet FMB

N° de code Bestell Nr Order Nr	Ø D mm	L mm	M1 mm	M2 mm	Prix Frs Preis Price
VO9262.0000	5,5	69	Ø4,5 H7	M4	74.00
VO9263.0000	7,5	122	M6 x 0,75	M5 x 0,5	100.00
VO9264.0000	10	110	M8 x 0,75	M6 x 0,75	130.00
VO9265.0000	12			M7 x 0,75	150.00
VO9266.0001	15			M8 x 1	160.00
VO9267.0000	16			M8 x 1	179.00
VO9268.0000	18			M8 x 1	185.00
VO9269.0000	20		M14 x 1,5	M10 x 1	205.00
VO9270.0000	23			M10 x 1	215.00
VO9271.0000	25			M10 x 1	250.00
VO9272.0000	27			M10 x 1	250.00
VO9273.0000	30				270.00

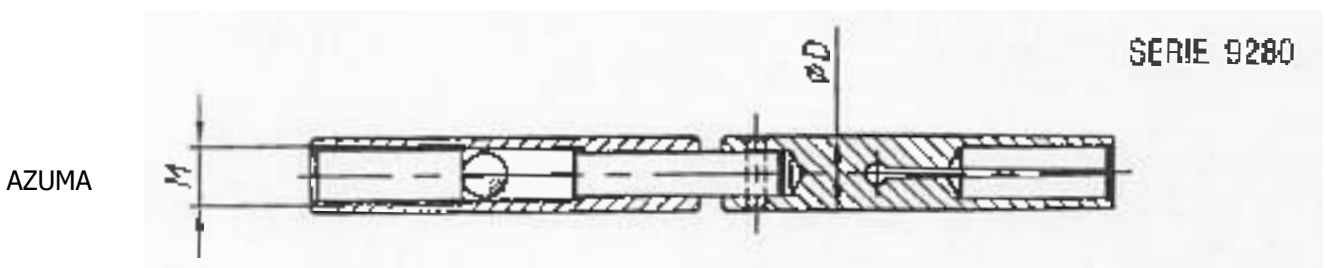

N° de code Bestell Nr Order Nr	Ø D mm	M1 mm	Prix Frs Preis Price
VO9280.0000	5,5	M4,5 x 0,5	96.00
VO9281.0000	8	M6 x 0,75	100.00
VO9282.0000	10	M8 x 0,75	106.00
VO9283.0000	12	M8 x 0,75	116.00
VO9284.0000	14	M8 x 0,75	124.00



**PORTE-CENTREURS TYPE K
ZENTRIERBOHRER-HALTER TYP K
CENTER DRILL HOLDERS TYPE K**

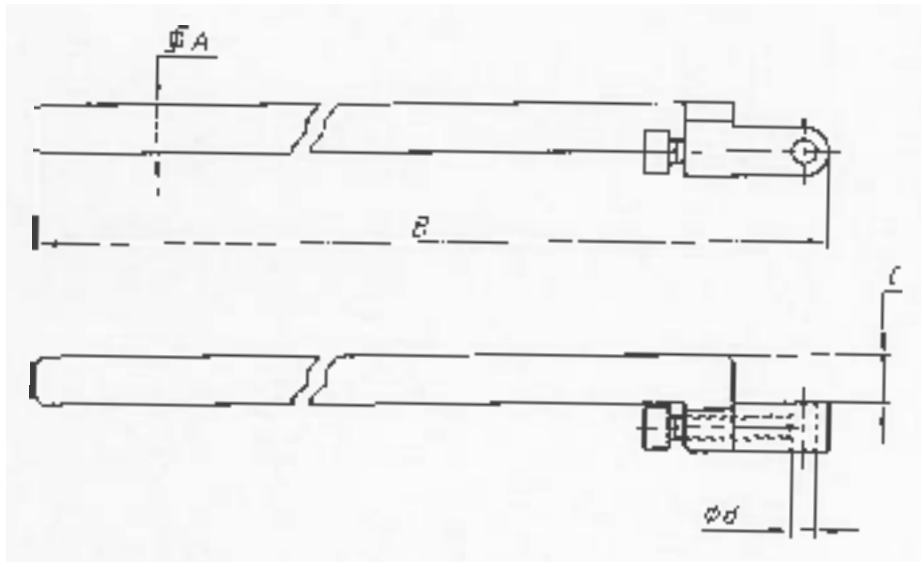

Gauche / Links / Left

N° de code Bestell Nr Order Nr	\square A mm	B mm	C mm	Ø d mm	Prix Frs Preis Price
VO10120.0000	7 x 7	146	7	3	82.00
VO10121.0000	7 x 7	146	7	4	82.00
VO10122.0000	8 x 8	146	8	3	82.00
VO10123.0000	8 x 8	146	8	4	82.00
VO10124.0000	8 x 8	146	8	5	82.00
VO10125.0000	10 x 10	176	10	4	94.00
VO10126.0000	10 x 10	176	10	5	94.00
VO10127.0000	10 x 10	176	10	6	94.00
VO10128.0000	10 x 10	176	10	7	94.00
VO10129.0000	12 x 12	190	12	4	96.00
VO10130.0000	12 x 12	190	12	6	96.00
VO10131.0000	12 x 12	190	12	8	96.00
VO10132.0000	14 x 14	190	14	4	106.00
VO10133.0000	14 x 14	190	14	6	106.00
VO10134.0000	14 x 14	190	14	8	106.00
VO10135.0000	14 x 14	190	14	10	106.00



**PORTE-OUTILS DÉCALÉS POUR TOURNAGE INTÉRIEUR
VERSETZTE WERZEUG HALTER ZUM INNENDREHEN
DISPLACED TOOL HOLDERS FOR INSIDE TURNING**

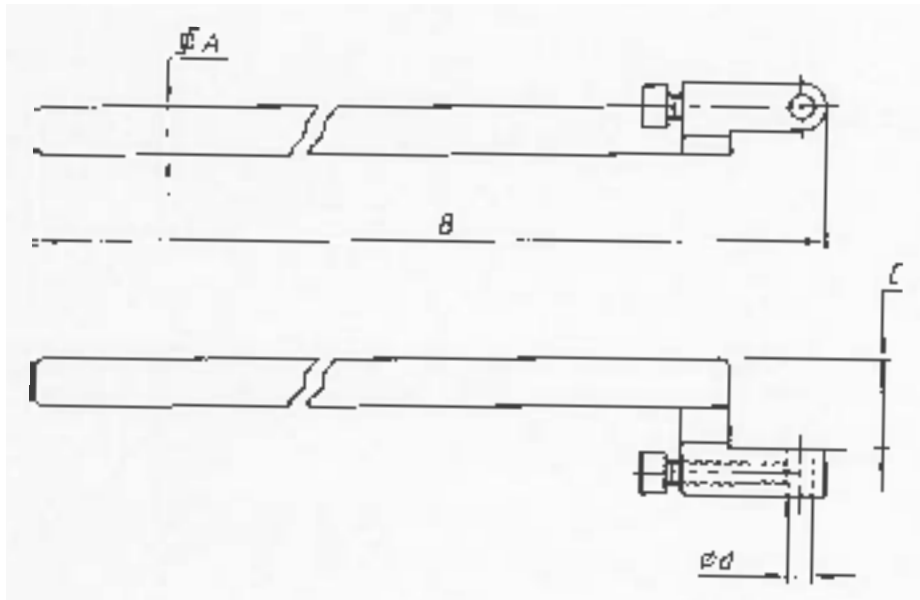

Droite / Rechts / Right

N° de code Bestell Nr Order Nr	□ A mm	B mm	C mm	Ø d mm	Prix Frs Preis Price
VO10140.0000	7 x 7	146	12	4	92.00
VO10141.0000	8 x 8	146	12	4	92.00
VO10142.0000	8 x 8	146	15	5	92.00
VO10143.0000	8 x 8	146	20	5	92.00
VO10144.0000	10 x 10	176	20	6	104.00
VO10145.0000	12 x 12	190	18	6	106.00
VO10146.0000	12 x 12	190	24	8	106.00
VO10147.0000	14 x 14	190	20	8	116.00
VO10148.0000	14 x 14	190	24	8	116.00



**PORTE-OUTILS DÉCALÉS POUR TOURNAGE INTÉRIEUR
VERSETZTE WERZEUG HALTER ZUM INNENDREHEN
DISPLACED TOOL HOLDERS FOR INSIDE TURNING**

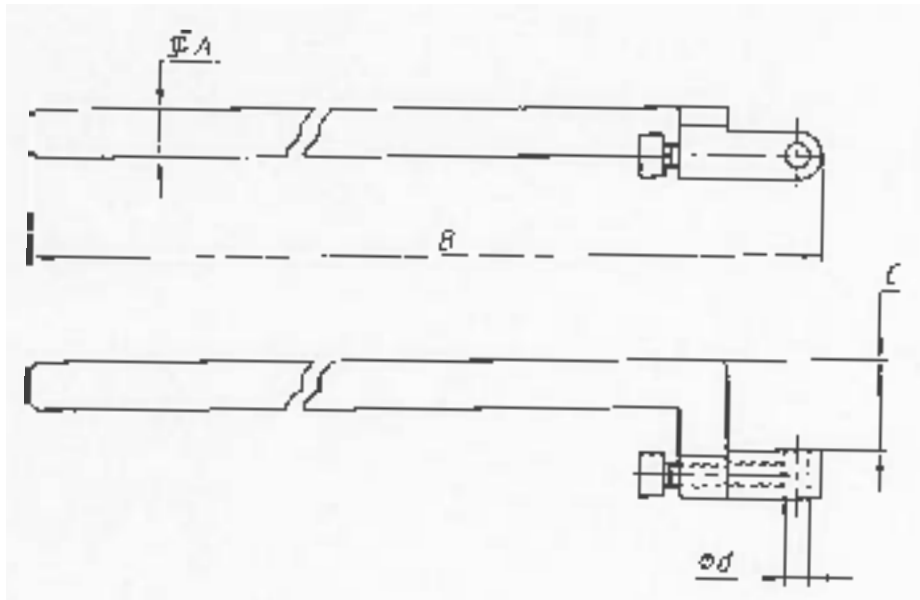

Gauche / Links / Left

N° de code Bestell Nr Order Nr	\square A mm	B mm	C mm	\emptyset d mm	Prix Frs Preis Price
VO10150.0000	7 x 7	146	12	4	92.00
VO10151.0000	8 x 8	146	12	4	92.00
VO10152.0000	8 x 8	146	15	5	92.00
VO10153.0000	8 x 8	146	20	5	92.00
VO10154.0000	10 x 10	176	20	6	104.00
VO10155.0000	12 x 12	190	18	6	106.00
VO10156.0000	12 x 12	190	24	8	106.00
VO10157.0000	14 x 14	190	20	8	116.00
VO10158.0000	14 x 14	190	24	8	116.00



**PORTE-FILIÈRES À VIS ET REVIDAGE D'APPUI
SCHNEIDEISEN-HALTER MIT SCHRAUBE UND STUETZE
DIE HOLDEER WITH SCREW UND SUPPORT PART**

Court / Kurze / Short



N° de code Bestell Nr Order Nr	Ø d mm	Ø D mm	L1 mm	L2 mm	C mm	Prix Frs Preis Price
VO10350.0003	3	12	70	15,5	8,25	95.00
VO10350.0004	4	12	70	15,5	8,25	95.00
VO10350.0005	5	12	70	15,5	8,25	95.00
VO10351.0003	3	16	70	16,5	12,20	97.00
VO10351.0004	4	16	70	16,5	12,20	97.00
VO10351.0005	5	16	70	16,5	12,20	97.00
VO10352.0003	3	20	78	27	15	99.00
VO10352.0004	4	20	78	27	15	99.00
VO10352.0005	5	20	78	27	15	99.00
VO10352.0007	7	20	78	27	15	99.00
VO10352.0008	8	20	78	27	15	99.00
VO10352.0010	8	25	78	27	19	115.00

Long / Lange / Long

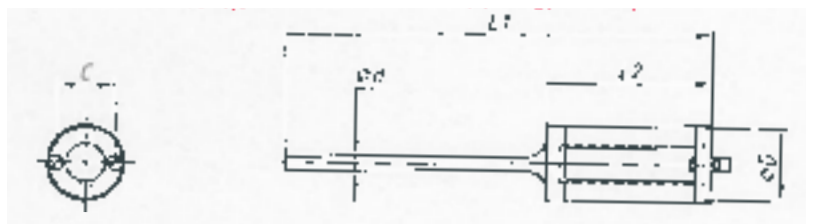

N° de code Bestell Nr Order Nr	Ø d mm	Ø D mm	L1 mm	L2 mm	C mm	Prix Frs Preis Price
VO10353.0003	3	12	88	34	8,25	103.00
VO10353.0004	4	12	88	34	8,25	103.00
VO10353.0005	5	12	88	34	8,25	103.00
VO10354.0003	3	16	88	34	12,20	105.00
VO10354.0004	4	16	88	34	12,20	105.00
VO10354.0005	5	16	88	34	12,20	105.00
VO10355.0003	3	20	92	38	15	108.00
VO10355.0004	4	20	92	38	15	108.00
VO10355.0005	5	20	92	38	15	108.00
VO10355.0007	7	20	92	38	15	108.00
VO10355.0008	8	20	92	38	15	110.00



**PORTE-MÈCHES ET PORTE-TARAUDS
BOHRER UND GEWINDEBOHRERHALTER
DRILL AND TAPE HOLDERS**

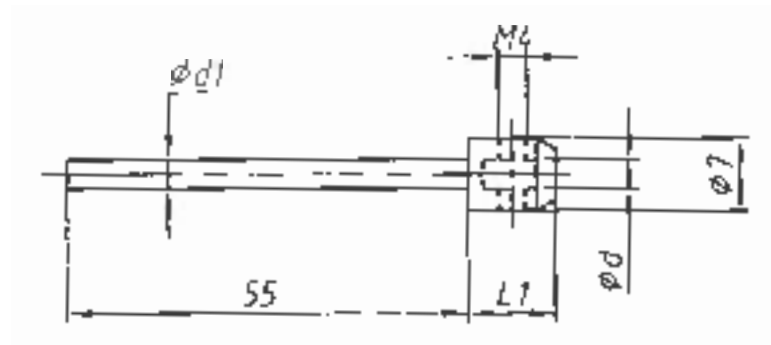

N° de code Bestell Nr Order Nr	Ø d1 mm	L1 mm	Ø d mm	Prix Frs Preis Price
VO10360.0000	3	12	1 - 1,5 - 2 - 2,5	58.00
VO10361.0000	4	12	1 - 1,5 - 2 - 2,5	58.00
VO10362.0000	5	12	1 - 1,5 - 2 - 2,5 - 3	58.00
VO10363.0000	3	20	1 - 1,5 - 2 - 2,5	75.00
VO10364.0000	4	20	1 - 1,5 - 2 - 2,5	75.00
VO10365.0000	5	20	1 - 1,5 - 2 - 2,5 - 3	75.00

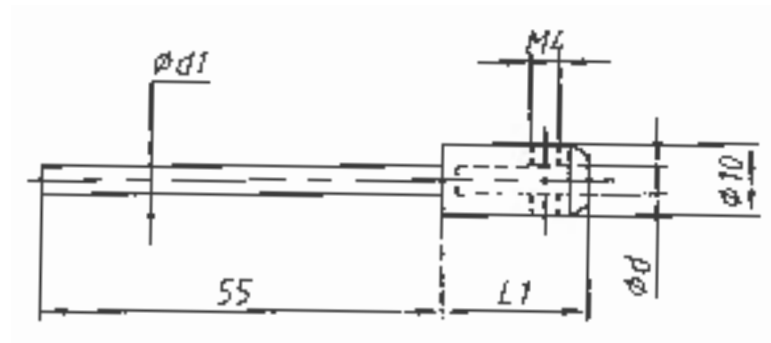

N° de code Bestell Nr Order Nr	Ø d1 mm	L1 mm	Ø d mm	Prix Frs Preis Price
VO10370.0000	3	12	1 - 1,5 - 2 - 2,5	58.00
VO10371.0000	4	12	1 - 1,5 - 2 - 2,5	58.00
VO10372.0000	5	12	1 - 1,5 - 2 - 2,5 - 3	58.00
VO10373.0000	3	20	1 - 1,5 - 2 - 2,5	75.00
VO10374.0000	4	20	1 - 1,5 - 2 - 2,5	75.00
VO10375.0000	5	20	1 - 1,5 - 2 - 2,5 - 3	75.00



PORTE-MÈCHES ET PORTE-TARAUDS À ÉCROU MOLETÉ
BOHRER UND GEWINDEBOHRERHALTER GERANDELTE SMUTTE
DRILL AND TAPE HOLDERS KNURLED NUT

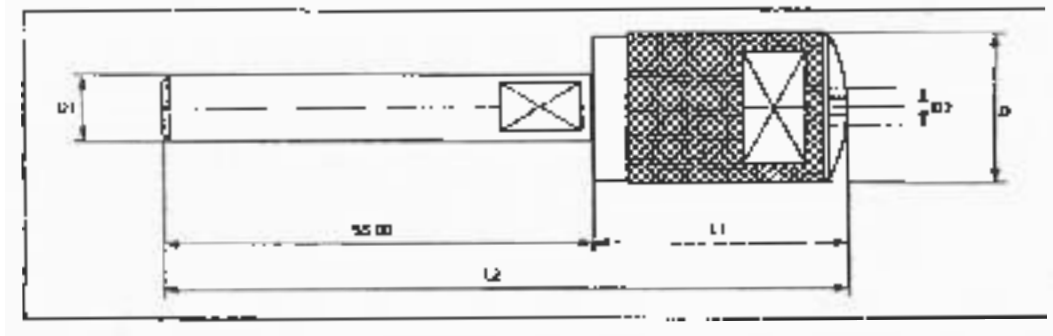

N° de code Bestell Nr Order Nr	D1	L1	D2	L2	D2	Prix Frs Preis Price
VO10376.0000	3	15	10	67	1,00 - 1,5, - 2,00 - 2,50	161.00
VO10377.0000	4	15	10	67	1,00 - 1,5, - 2,00 - 2,50 - 3,00	161.00
VO10378.0000	5	15	10	90	1,00 - 1,5, - 2,00 - 2,50 - 3,00	161.00



**PINCES D'AVANCE
VORSCHUBZANGEN
FEEDFINGERS**

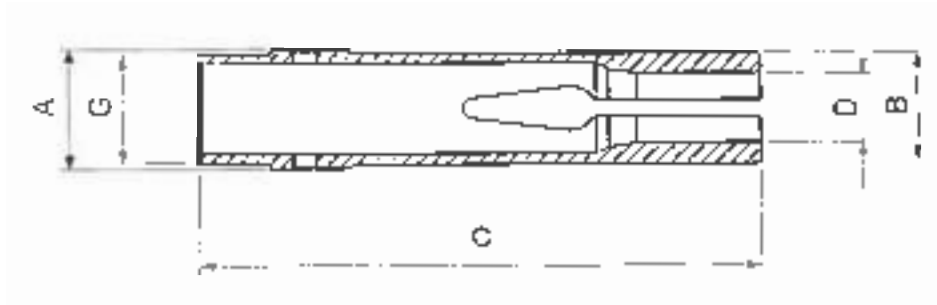

A	B	C	G	D min. - max.	Prix Frs Preis Price
17,9	17,5	70	M16 x 0,75	1,5 - 16	
19,9	17,5	70	M16 x 0,75		
22,8	20,5	98	M20 x 0,75	2,5 x 17	
22,8	20,5	98	M20 x 0,75		
25	25	90	M24 x 1	3 - 20	
27,7	25,3	116	M25 x 1	2 - 21	
35	33	118	M33 x 1,5	3 - 26	

PINCES POUR MULTISWISS

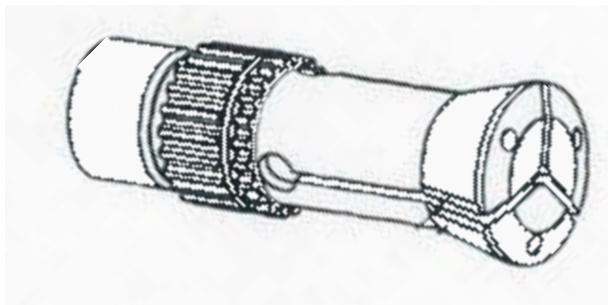

Alésage mm Bohrung Bore	Prix Frs Preis Price
3 - 16	